

Pathways to Parity - Market insight series

# Energy Storage - Towards a commercial model - 2<sup>nd</sup> Edition

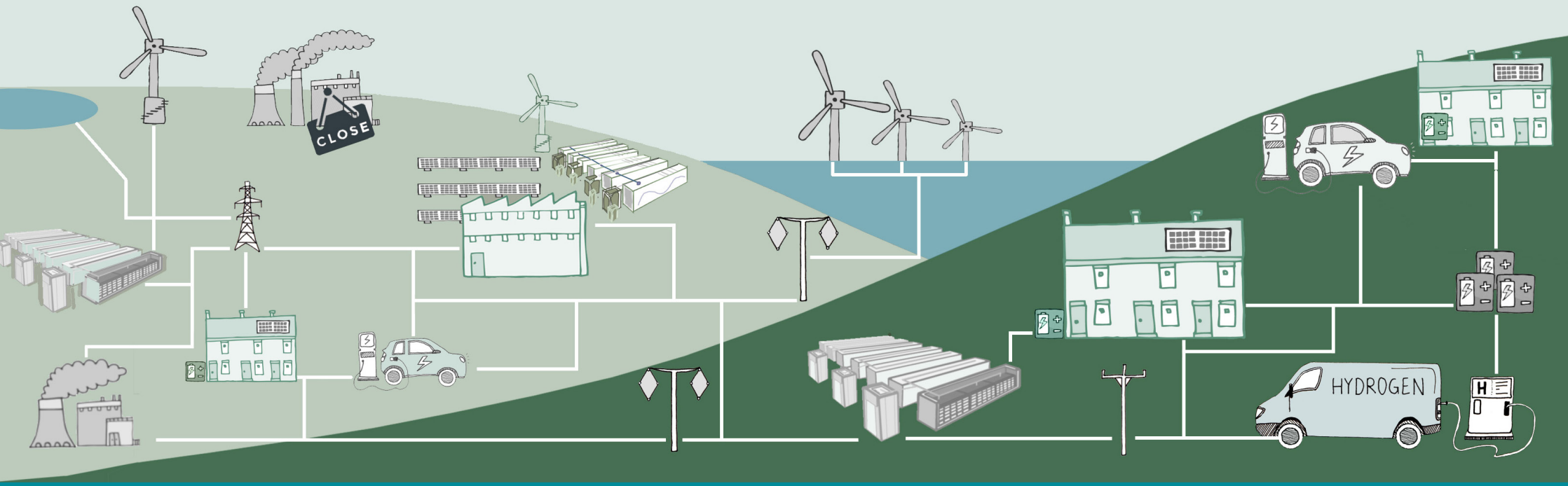

Sponsored by:



Triodos  Bank

# Thank you to our sponsors

The Pathways to Parity series papers are independently produced and represent the views of Regen SW. Each paper has, however, benefited from input and support from industry, including Regen members and our industry sponsors. Thanks also to the many industry reports that have preceded this one and on which we have inevitably drawn, which are listed as references and in the further reading section.

The sponsors for this paper are TLT Solicitors, Green Hedge International and Triodos Bank:



TLT has been involved in the renewable energy sector for nearly 20 years, advising on a wide range of projects for a variety of different organisations. TLT's experienced legal team is one of the few that can provide UK-wide legal advice, supporting projects in England, Wales, Scotland and Northern Ireland. TLT's clients span the sector, from high growth entrepreneurial companies to large utilities. TLT acts for all parties involved in successful projects, including developers, banks, equity investors, contractors and suppliers. They have also advised government departments, in relation to the implementation and operation of energy efficiency and renewables policy.



Green Hedge is a leading developer and operator of low carbon electricity generation and storage projects. The group's developer arm has developed over 200 megawatts of renewable energy projects to date, with a focus on large-scale grid connected and private wire solar PV systems. The group's fast-growing O&M business provides operation and maintenance services for ground mounted solar farms. With over 150 megawatts under contract in the UK, it is one of the country's top independent O&M providers. In the UK, Green Hedge has created The Energy Barn™ and is currently developing one of the largest pipelines of battery storage assets in the local market. UK O&M provider Green Hedge Solar Operations serves a growing number of customers and solar farms, and is dedicated to delivering intelligent, rigorous and cost effective O&M solutions that help our clients optimise the value of their solar farms.



Triodos Bank is a global pioneer in sustainable banking using the power of finance to invest in projects that are good for people and the planet. Triodos uses its €12 billion in assets to create social, environmental and cultural value in a transparent and sustainable way. Triodos only finances loan customers from large ethical loan customers to smaller, innovative organisations meeting local needs. Triodos Bank has over 20 years' experience of investing in renewable energy. As part of its mission to make money work for positive social and environmental change, it has built up a strong track record in this area, having funded hundreds of sustainable energy projects across Europe.

|                                                                                       |           |
|---------------------------------------------------------------------------------------|-----------|
| <b>Introduction</b> .....                                                             | <b>4</b>  |
| <b>A smart power revolution and the value of flexibility</b> .....                    | <b>6</b>  |
| <b>The role of energy storage</b> .....                                               | <b>9</b>  |
| <b>Energy storage technologies - a brief summary</b> .....                            | <b>10</b> |
| <b>Projections for energy storage costs</b> .....                                     | <b>15</b> |
| <b>Potential revenue streams</b> .....                                                | <b>19</b> |
| <b>Paying for the grid - electricity network charging for a flexible future</b> ..... | <b>22</b> |
| <b>Building a sustainable business case</b> .....                                     | <b>24</b> |
| <b>Growth scenario for a future energy storage market</b> .....                       | <b>34</b> |
| <b>Regulatory and legal constraints and issues</b> .....                              | <b>36</b> |
| <b>Conclusion - Towards a commercial future</b> .....                                 | <b>38</b> |
| <b>Reference documents and further reading</b> .....                                  | <b>40</b> |

Written and produced by Regen SW  
Designed by Highbridge Business Support Agency  
Printed on 100 per cent recycled paper on a printing press  
powered by renewables

Regen SW passionately believes that sustainable energy has a vital role at the heart of a successful economy and thriving local communities. We are an independent not-for-profit that uses our expertise to work with industry, communities and the public sector to revolutionise the way we generate, supply and use energy. We are ambitious on the scale of our impact and aim to be the leading national experts in how to enable radical change in the energy system at a local level. We're experts in how sustainable energy works, and what needs to be done to make it work better, in areas such as technical, financial, business model and policy change.

#### Disclaimer

This market insight document is intended for general dissemination in the hope of encouraging debate and discussion between industry, decision makers and policy stakeholders. It is not intended to inform or otherwise influence financial investment or commercial decisions. While Regen SW considers the information and opinions given in this report to be reasonable based on currently available information, Regen SW offers no warranty or assurance as to the accuracy and completeness of the information contained in this report.

Specifically Regen SW would highlight that in the rapidly changing sector of energy and energy storage, all references given to technology performance, financial figures, costs and revenues must be considered as illustrative and subject to significant variance and uncertainty.

While Regen SW has sought industry and third party input to inform the report, this report has not been subject to independent verification. All opinions and forward projections contained in the report are those of Regen SW, and do not represent the views of any third party or sponsor organisation unless specifically ascribed.

Inevitably the report draws on previous reports and published material which cover the same ground. We have referenced those where appropriate within the document and in the further reading section but apologise in advance if, in the interests of readability, we may have omitted to reference appropriately.

Readers of this report are encouraged to use their own judgement and research in assessing the energy storage market opportunity. We would welcome feedback and comment on any aspects of the report and look forward to continuing an active debate with our industry colleagues.

## About the “Pathways to Parity Series”

As the UK renewable energy sector faces up to dramatic policy changes, including a precipitous fall in subsidy support, Regen SW’s new series of thought leadership papers and events will explore emerging business models that we believe will make clean energy the backbone of our future electricity system.

The papers are intended to present a balanced analysis of the future market opportunities and challenges faced by the renewable energy and low carbon industries.

They are underpinned by a strong belief that the UK can play a significant role in the global effort to combat climate change. Specifically, the reports take as their starting point the UK government’s legal commitments to decarbonisation, manifested through the Climate Change Act (2008), international commitments made at the Paris COP 2015 and its recent enactment of the 5th Carbon Budget<sup>1</sup>.

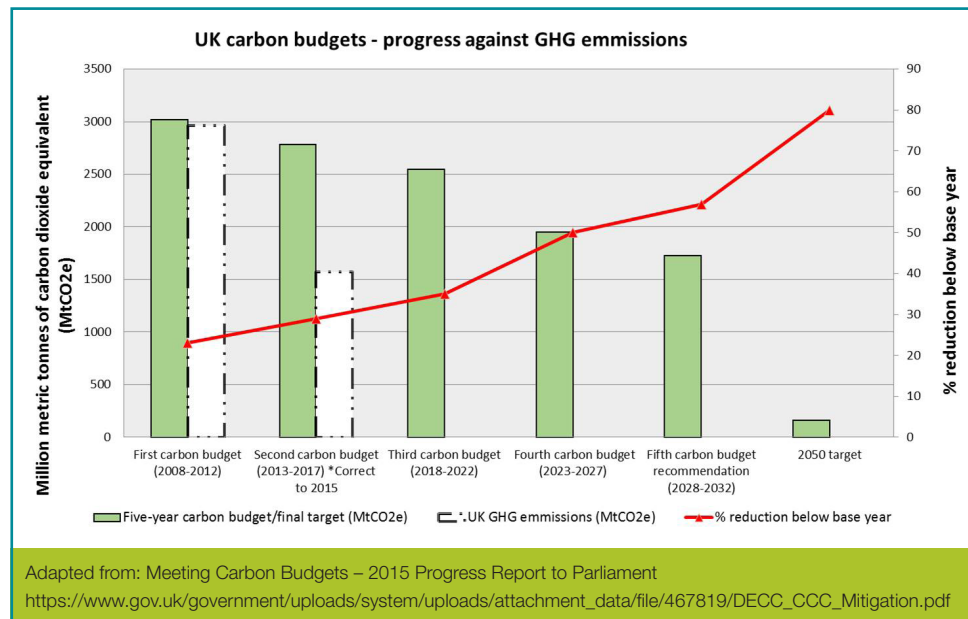

The context, therefore, is that the UK will decarbonise all aspects of its energy usage in the coming decades, including its power generation, heat and transport systems. This means nothing less than a revolution in the UK’s energy system, through the deployment and development of smarter low carbon technologies, increased energy efficiency and a radical shift away from the traditional model based on carbon emitting fossil fuels.

Alongside decarbonisation, a relatively new priority for energy policy, energy security will continue to be a fundamental requirement of the energy system, both in terms of the short term prerequisite to “keep the lights on” in the coming winter, and the long term strategic goal of securing access to the technologies and resources necessary to maintain a long term energy supply.

### A Smarter more flexible energy system

There is a general consensus that the UK needs a smarter and more flexible energy system for the future which will deliver cleaner and cheaper energy. The big questions are about how we get there. The government and Ofgem has now issued its long awaited call for evidence<sup>2</sup> on “A smart, flexible energy system” which goes some way to outline the current policy priorities and suggests that, while being technology neutral, the UK will look to enable “a system that allows disruptive innovation... New business models could challenge incumbents... Where these could bring overall benefits to consumers, we should allow them to do so”.

<sup>1</sup> UK 5th Carbon Budget adopted by UK Government July 2016 commits the UK to a 57 per cent reduction in CO<sub>2</sub> by 2032 and to remain on track to all but eliminate carbon emission by 2050

<sup>2</sup> BEIS and Ofgem Call for Evidence “A Smart, Flexible Energy System” November 2016

## Energy storage – a market poised for growth

Energy storage could play a significant role, alongside other measures, in providing greater flexibility in our energy system, balancing energy demand and supply and enabling a more rapid and greater deployment of variable low carbon generation. In capacity terms, it has been estimated that this could amount to as much as 18.3 GW under the consumer power scenario of the 2016 National Grid “Future Energy Scenarios” analysis.

During our workshops and discussions with industry and stakeholders, we have used the analogy of an unsolved Rubik’s Cube™ to describe the current state of the energy storage market. The analogy is intended to convey the multi-dimensional complexity of the market, including its technologies, potential applications and revenue streams, customers and routes to market, plus the underlying complexity of the UK’s energy policy and regulatory environment. The analogy also conveys the sense that, despite the growing interest in energy storage, the current market is still at an early stage of development and there is still a degree of misalignment between the various commercial drivers and barriers to growth.

- Technology costs have fallen rapidly but most storage technologies are still comparatively expensive compared to the cheapest generation technologies.
- There are a number of potential revenue streams, but the route to market for several of these are not well defined.
- The elements required to make a viable business case are almost in place, but uncertainty and a lack of precedent is hindering investment.
- Technologies are on the cusp of major advancement to harness the undoubted value that energy storage could deliver.
- The regulatory and policy environment is not yet in place to ensure investor confidence and to enable sustained sector growth.

This paper does not solve the Rubik’s Cube™, but we hope that it will go some way to summarise and explain some of the key elements of the puzzle and add to active discussion between industry and policymakers trying to determine the role that energy storage could play and how best to facilitate market development. The paper touches very briefly on the various storage technologies, but the focus is on the future market development pathway, including the dimensions of cost, revenue streams and the emerging energy storage business models.

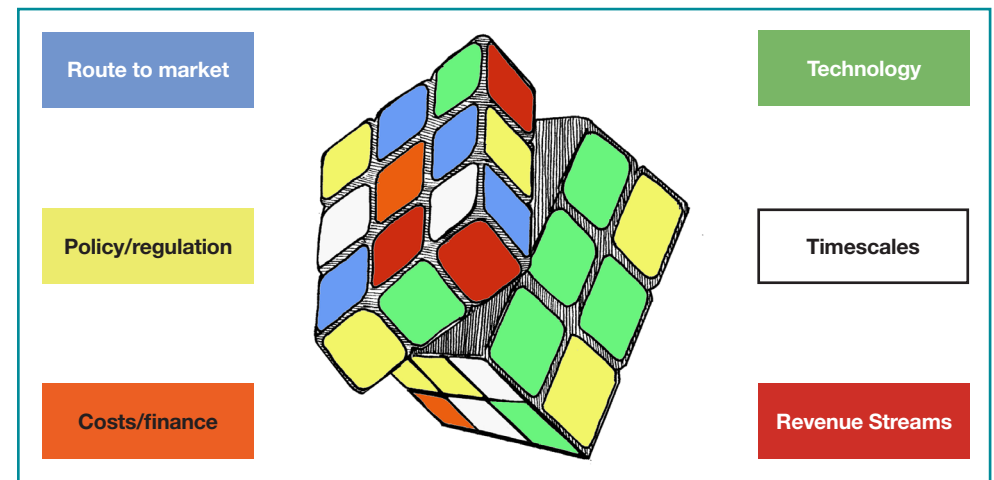

The paper identifies some of the key barriers and enabling actions that need to be addressed to accelerate technology development and market growth as part of a wider industrial strategy for smarter low carbon energy. The report’s conclusion is that, while there are challenges and uncertainties, the UK has the potential to create a significant energy storage sector, and to export the knowledge and capabilities that will be generated to the global energy market.

# A smart power revolution and the value of flexibility

As the UK energy system undergoes radical change, the value attached to flexibility has greatly increased. Whether technological or through new business models, flexibility is set to become a key enabler of the “smart power revolution” helping to maximise the use of low carbon generation, manage the supply/demand balance, optimise infrastructure investment and make best use of the lowest cost energy.

Energy markets around the world have committed to decarbonisation and are now grappling with the issues caused by a rapid transition away from a largely centralised energy system using carbon intense, but easily controllable, fossil fuels, towards a system which is more decentralised, smarter and cleaner.

This more decentralised system is characterised by higher levels of renewable energy and local generation, creating the opportunity for increased use of energy storage, smart energy applications and new business models based on localised energy markets and demand/supply balancing.

In the past 5 years, the UK has achieved a rapid expansion in renewable electricity generation and, as of 2015, renewables provided around 22.3 per cent or 88.6 TWh of our annual electricity generation. Of this 57.3 per cent or 50.7 TWh came from variable sources - mainly from onshore and offshore wind and solar photovoltaics (PV)<sup>3</sup>.

## A rapidly changing energy system

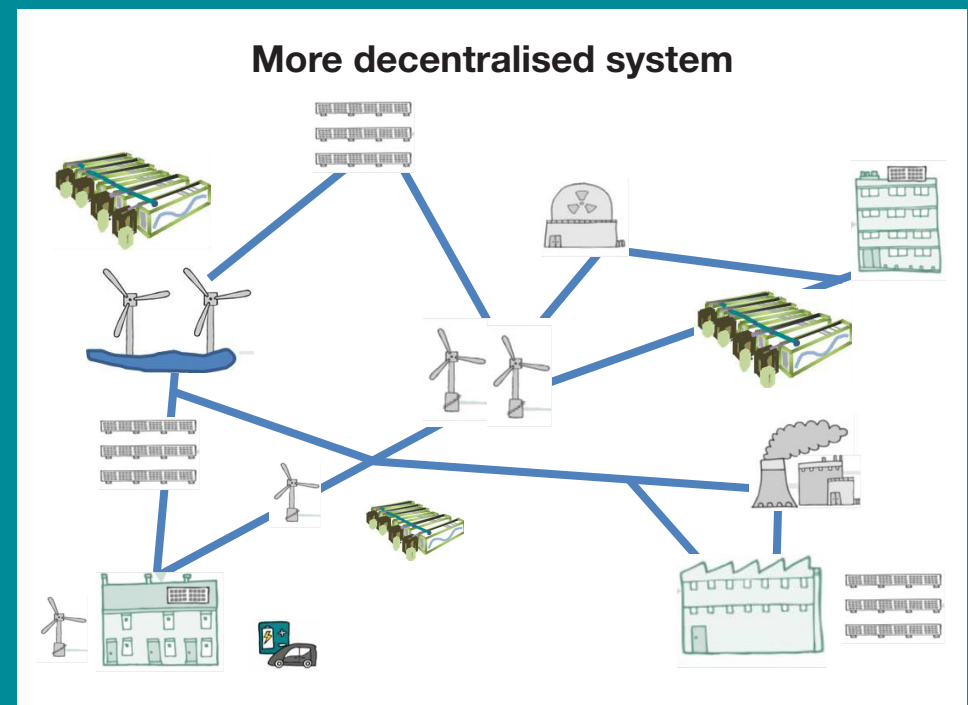
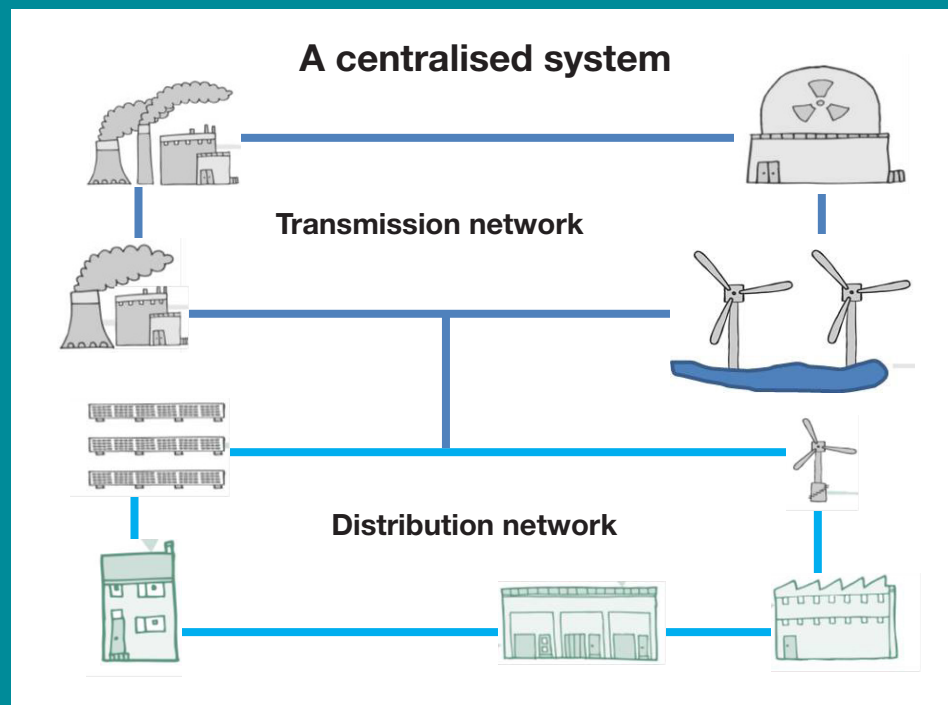

<sup>3</sup>Data analysis from the June 2016 DECC & National Statistics Energy Trends

## The UK energy system under pressure

The UK transmission and distribution grid networks have managed to support a significant capacity of low carbon energy generation to date. However, it is now recognised that the increase in variable generation, when combined with the variability of the UK's energy demand and the closure of older generating capacity, has increased the challenge of balancing network demand and supply.

With an estimated circa 30 GW of older coal, oil, gas and nuclear generation due to be de-commissioned by 2025, a possible future capacity "gap" is looming large over the UK energy system. Despite increasing energy efficiency, the anticipated electrification of transport and heat will further add to the UK's future electricity demand.

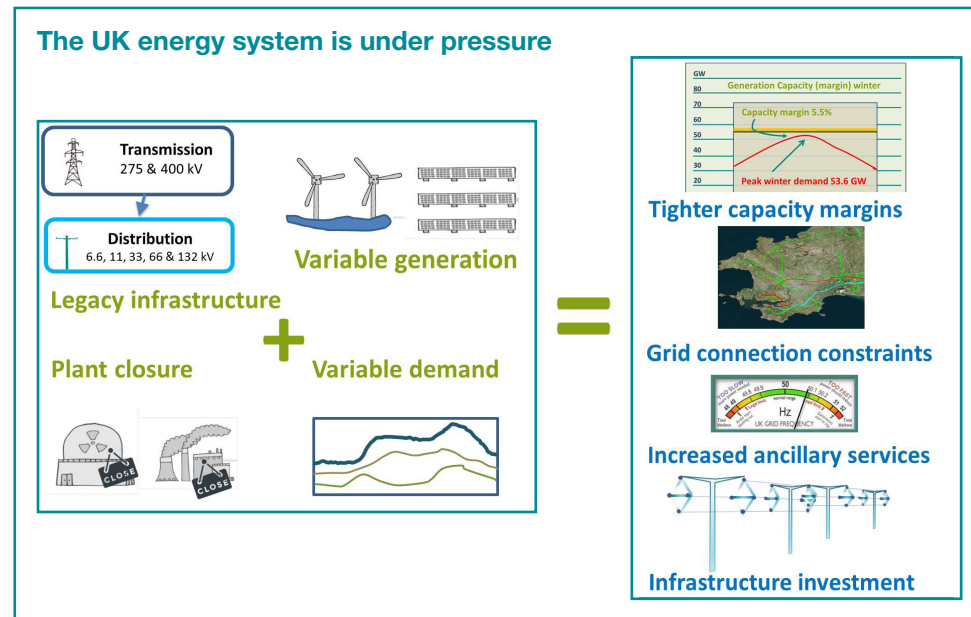

- Decentralised generation capacity has reached the point where connection delays and generation curtailment are now commonplace.
- The “capacity margin”, the buffer between peak demand and supply, has tightened, forcing National Grid to take measures to secure additional capacity<sup>4</sup>.
- There is greater need for ancillary services to regulate network frequency and voltage.
- The need for new investment means that the UK could spend an estimated £200 billion<sup>5</sup> to upgrade its generation and transmission infrastructure over the next ten years.

### The capacity gap shortfall could in part be addressed by:

- Construction of 8 GW<sup>6</sup> offshore wind by 2026 with potential for a further 6 GW by 2030.
- European grid interconnectors which could add an additional 5-7 GW of equivalent capacity.
- A future round of gas fired power station construction which could add a further 7 GW<sup>7</sup> of gas generation by 2022.
- New nuclear, potentially the deployment of Small Modular Reactors (SMRs), given uncertainty surrounding large scale projects.

<sup>4</sup> National Grid Winter Review 2016

<sup>5</sup> National Grid TIO review

<sup>6</sup> 4-5 GW awaiting construction 2020, and a further 10 GW by 2030 announced by Sec of State DECC 18th November 2015.

<sup>7</sup> National Grid Future Energy Scenarios 2016 figure 1.4 Roadmap to over 7 GW of new gas capacity by 2022

## Investing in flexibility

There is no doubt that investment in new generation capacity and network infrastructure is needed. The question is the degree to which the UK follows a strategy that will concentrate investment in “over-capacity” to meet variable energy demand, versus a “smarter” approach that combines new capacity with increased levels of flexibility within the system.

The cost differential, as the National Infrastructure Commission<sup>8</sup> has identified, could be enormous, with potentially over £8 billion of savings per year to the energy consumer if the UK achieves a CO<sub>2</sub> decarbonisation target of 50g per kWh. Later this year Ofgem and the Department of Business, Energy and Industrial Strategy (BEIS) will issue a call for evidence on how to respond to the conclusions of the National Infrastructure Commission report. This will be a first opportunity for the new government department to set out its future energy vision, explicitly linked to an ambitious industrial strategy.

“Three innovations will help us deliver greater flexibility – interconnection, storage, and demand flexibility – which have the potential to displace part of the need for new generating capacity, save money for businesses and domestic consumers and help the UK meet its climate reduction targets. The saving could be as large as £8 billion a year by 2030.”

Lord Andrew Adonis, Chair, The National Infrastructure Commission

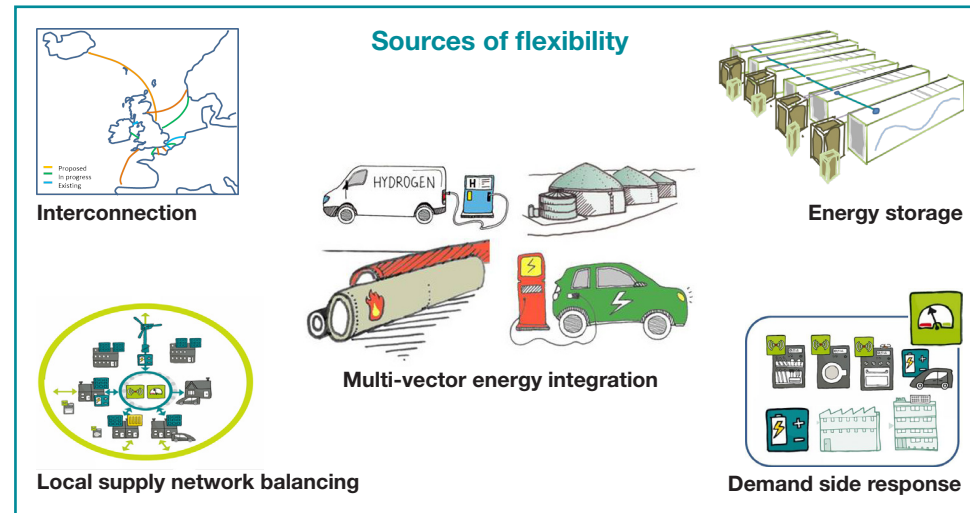

“The government will lay the foundations for a smart power revolution, with support for innovation in storage and other smart technologies, and an increased level of ambition on interconnection, which the NIC estimates could unlock benefits to UK consumers of up to £8 billion per year.”

George Osborne, 16 March 2016  
Budget Statement

Getting the balance right will be a challenge - whether to focus on increasing generating capacity or to combine energy generating capacity with new sources of flexibility. The obvious, and most cost effective answer is a combination of both, but in the short term the priority will be to secure new capacity onto the network. This will focus government's efforts in trying to get at least 7 GW of new gas generation built by 2022, but at the potential risk of losing sight of the wider energy goals, including investment in innovation, flexibility and decarbonisation.

<sup>8</sup> National Infrastructure Commission, 2015, Smart Power



# The role of energy storage

As a source of flexibility and security, energy storage is expected to become one of the key enabling technologies to help to revolutionise the way we use and manage our energy systems in the future.

Energy storage is not a new concept; stockpiles of fossil fuels, pumped hydro, flywheels, stored heat and even the humble hot water tank have been at the heart of our energy system for years. Energy storage is in fact all around us: in our computers, phones, cars, hand tools, vacuum cleaners and a host of other applications.

The reason there is so much focus on energy storage now is that the anticipated fall in costs for storage technologies, combined with the use of ICT platforms to integrate, aggregate and manage storage assets, has opened the possibility for much smarter storage solutions and new business models to harness its potential.

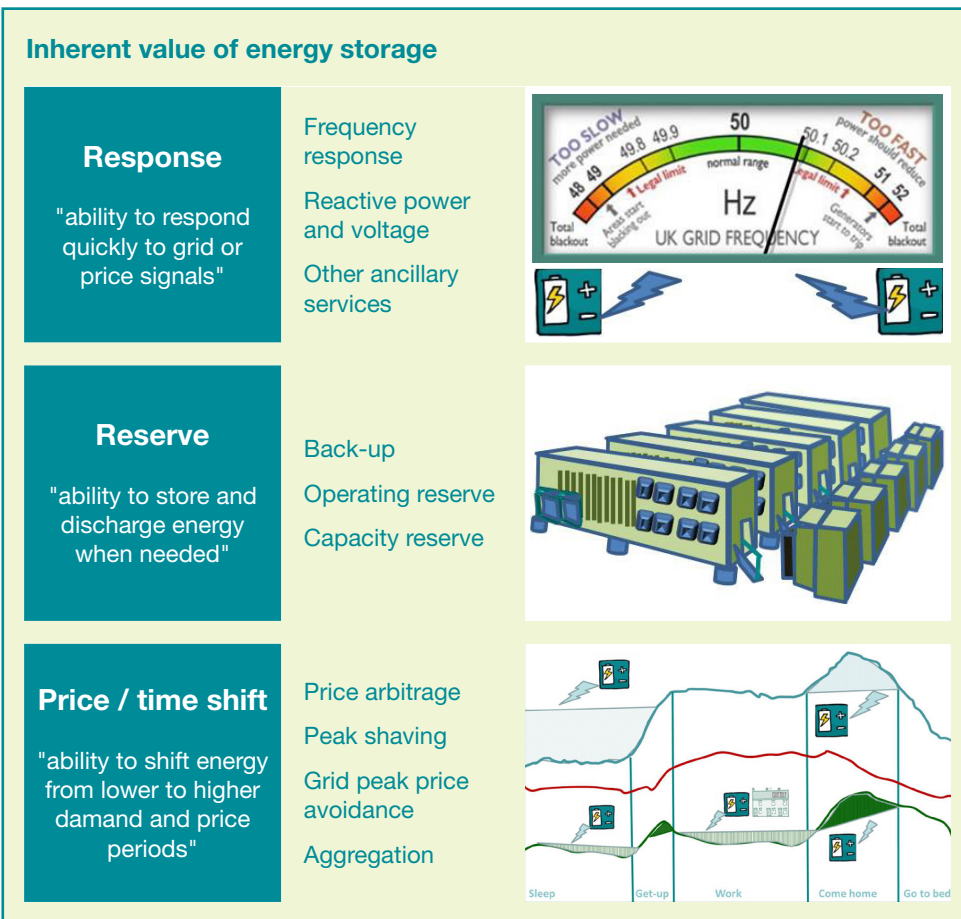

There are several ways to categorise energy storage technologies and their range of applications. For the purpose of this report we will focus on the inherent function or utility that energy storage provides as a source of energy reserve, response and time/price shift.

- **Response:** The ability to respond quickly (milliseconds – minutes) to grid, frequency and/or price signals. Potential applications include the provision of ancillary network services such as frequency response and voltage support.
- **Reserve:** The fundamental property of energy storage that enables the storage of energy to be used at a time when it is required. From a simple back-up capability for use as an alternative source of energy, to large scale capacity reserve and Short Term Operating Reserve.
- **Price and time shift:** The capability to shift energy from lower to higher price/cost periods. A more sophisticated application of both reserve and response functions, allowing energy users and suppliers to take advantage of price variance (price arbitrage), avoid peak transmission and distribution costs and/or to recover energy that would be lost due to grid or other constraints.

# Energy storage technologies - a brief summary

The variety of energy storage technologies and their applications is enormous, too many to be covered in any detail in this report. The US Department of Energy provides a useful classification that divides energy storage technologies into a number of classes – chemical, electrical, thermal, electrochemical and mechanical – and within those classes a further division by technology types.

Project developers, familiar with more homogenous technologies such as solar photovoltaics and wind, will need to fully understand both the technical and economic attributes of each storage technology and match those to the services they intend to deliver.

Key parameters include the scale of project, from micro-storage technologies for domestic and vehicle use, up to commercial and utility scale storage technologies providing megawatts of power output.

Key performance characteristics include response times, cycle or round-trip efficiency, recharge and discharge rates and storage capacity.

| Main energy storage technologies <sup>9</sup> |                                                                                                                                                                               |                                                                                                                                                      |                  |                                  |
|-----------------------------------------------|-------------------------------------------------------------------------------------------------------------------------------------------------------------------------------|------------------------------------------------------------------------------------------------------------------------------------------------------|------------------|----------------------------------|
| Storage class                                 | Technology type (examples)                                                                                                                                                    | Typical technology attributes                                                                                                                        | Cycle efficiency | Response time                    |
| <b>Chemical</b>                               | <ul style="list-style-type: none"> <li>Hydrogen</li> <li>Synthetic natural gas</li> </ul>                                                                                     | <ul style="list-style-type: none"> <li>Medium to large scale</li> <li>Multi vector – power, heat &amp; transport</li> <li>Transferability</li> </ul> | 30-45%           | 10 minutes                       |
| <b>Electrical</b>                             | <ul style="list-style-type: none"> <li>Super capacitors</li> <li>Super conducting magnetic storage</li> </ul>                                                                 | <ul style="list-style-type: none"> <li>Very fast response times</li> <li>High efficiencies</li> </ul>                                                | 90-94%           | Milliseconds                     |
| <b>Thermal</b>                                | <ul style="list-style-type: none"> <li>Molten salt (Heat/CSP thermal)</li> <li>Packed bed heat storage</li> <li>SETS</li> </ul>                                               | <ul style="list-style-type: none"> <li>Multi-vector to heat</li> </ul>                                                                               | 30%              | Seconds to minutes               |
| <b>Electrochemical</b>                        | <ul style="list-style-type: none"> <li>Lead/acid</li> <li>Lithium-ion, Lithium-S, Lithium-polymer</li> <li>Sodium-ion, Sodium-sulphur(NaS)</li> <li>Nickel-cadmium</li> </ul> | <ul style="list-style-type: none"> <li>Small to medium scale</li> <li>Scalability – modular units</li> <li>Very fast response times</li> </ul>       | 75-95%           | Milliseconds                     |
| <b>Solid state</b>                            |                                                                                                                                                                               |                                                                                                                                                      |                  |                                  |
| <b>Flow state</b>                             | <ul style="list-style-type: none"> <li>Vanadium redox, Zinc bromide</li> </ul>                                                                                                | <ul style="list-style-type: none"> <li>Rapid charge capability</li> </ul>                                                                            | 60-75%           |                                  |
| <b>Mechanical</b>                             | <ul style="list-style-type: none"> <li>Flywheels</li> <li>Compressed Air Energy Storage (CAES)</li> <li>Pumped heat electrical storage</li> <li>Pumped hydro</li> </ul>       | <ul style="list-style-type: none"> <li>Large scale</li> <li>Long discharge periods</li> </ul>                                                        | 80-87%           | Instantaneous to seconds/minutes |

<sup>9</sup> Table data adapted from a number of sources including: Electric Power Research Institute & US Department of Energy - Electricity Energy Storage Technology Options A White Paper Primer on Applications, Costs, and Benefits – 2010, Adapted from: REA 'Energy Storage in the UK - An Overview' – 2015

## Response and reserve

A key consideration in the choice of storage technology and system design is the choice between “response” systems that are designed to provide rapid or instantaneous power for short periods of time, versus “reserve” or “time shift” systems that can provide power over an extended period and potentially at a larger scale. There is not a clear distinction and the same technology can, at a cost, often be tailored to provide a combination of “response” and “reserve” functions, but it is a useful starting point in thinking about different technology types.

**Modularisation**, accompanied by cost reduction, may mean battery storage units can be effectively scaled-up to provide larger multi-MW systems.

**Aggregation** – integrating and co-managing individual systems – could also create a virtual large scale storage solution.

However, while battery costs remain comparatively high, very large scale systems of >100MW will tend to be mechanical solutions such as pumped hydro and compressed air storage.

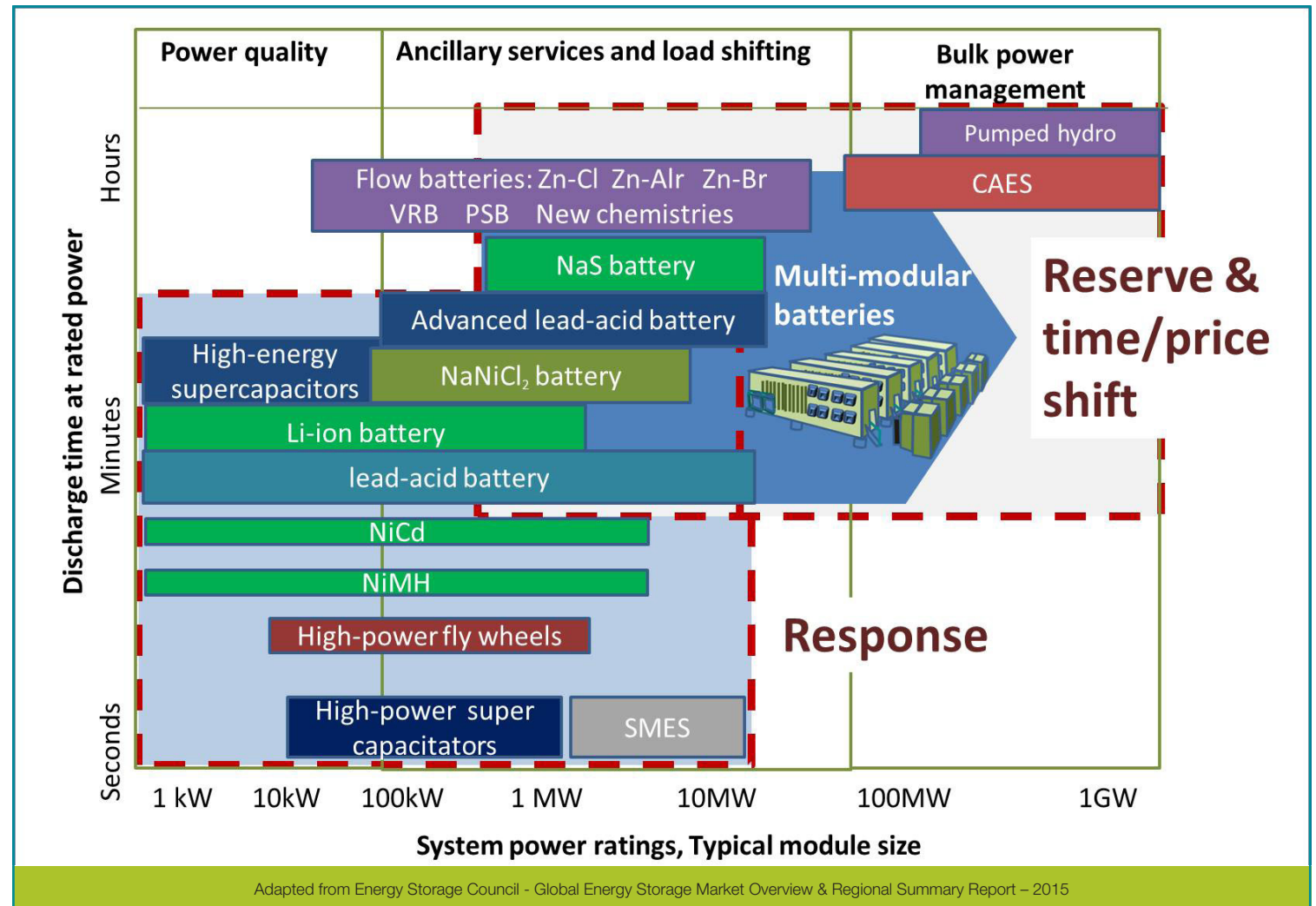

## Storage technology deployment

By capacity, more than 99 per cent of global energy storage is made up of large scale pumped hydro projects, utilised as core grid balancing infrastructure in traditional centralised energy systems. The largest UK pumped hydro scheme is the Dinorwig facility in Gwynedd at 1.72GW, which has been in operation since 1984, providing Short Term Operating Reserve (STOR) to balance network demand.

However, the requirement for decarbonisation is driving a move towards more decentralised, flexible energy systems and the use of other forms of storage is becoming increasingly economic across a wide range of applications. As battery manufacturing costs fall, this trend is set to increase. The focus will vary by market, and in the UK the recent surge in interest in new battery storage applications has been heightened by the growth of embedded variable generation and the increased need for flexibility and ancillary services for the UK grid network.

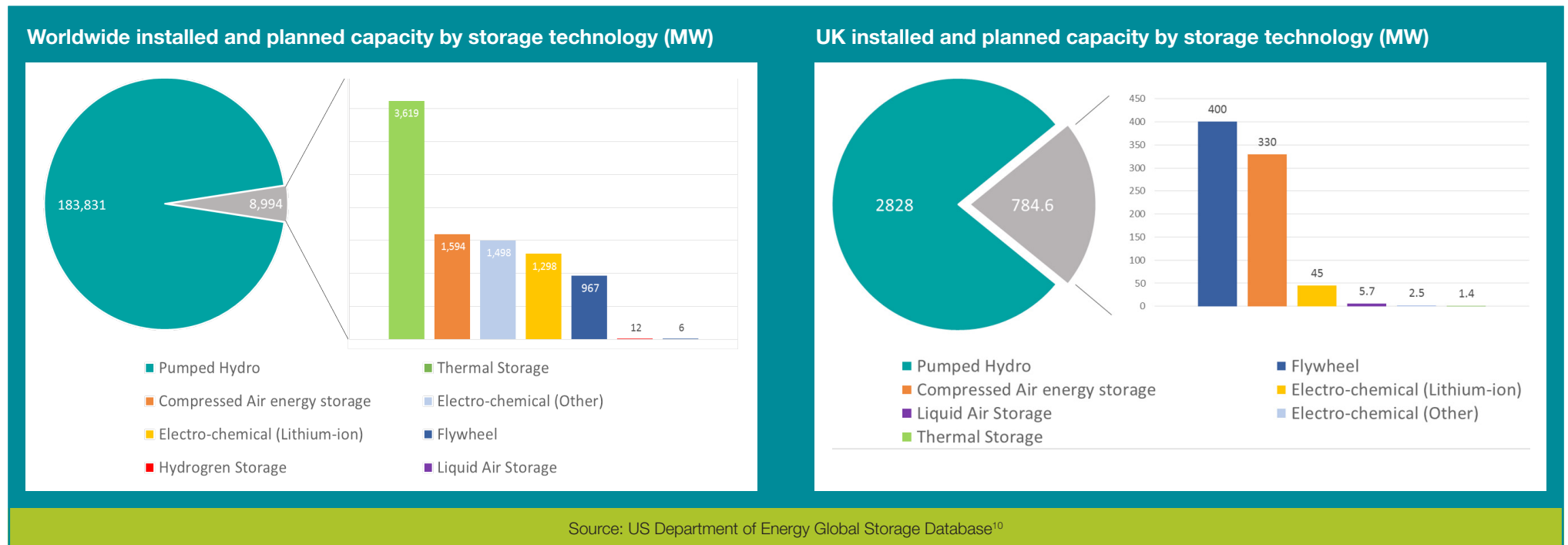

<sup>10</sup> Source US Department of Environment – Energy Storage Database Aug 2016 data

## UK energy storage demonstration and trial projects

The UK is currently trailing behind other countries in terms of the number of energy storage projects deployed, in particular the US, China, Japan and Germany. It is, however, in the top 10 countries for deployment and, with over 30 energy storage projects built or in the pipeline, the UK market is poised to grow rapidly, as projects progress from demonstration to commercial scale projects.

Projects numbers may not be the best measure of technology leadership. Significantly, a number of UK projects are demonstrating a high degree of technical sophistication and complexity, including the development of new business models, aggregation, grid integration and system controls.

This suggests that while the UK may not become a hub for battery manufacturing, it could become a centre for system architecture design, integration and business innovation.

In addition to hydro and pumped storage projects, there are now over 25 battery storage projects either in construction or operational in the UK<sup>11</sup>, several of these are associated with remote and island community micro-grid and energy security projects.

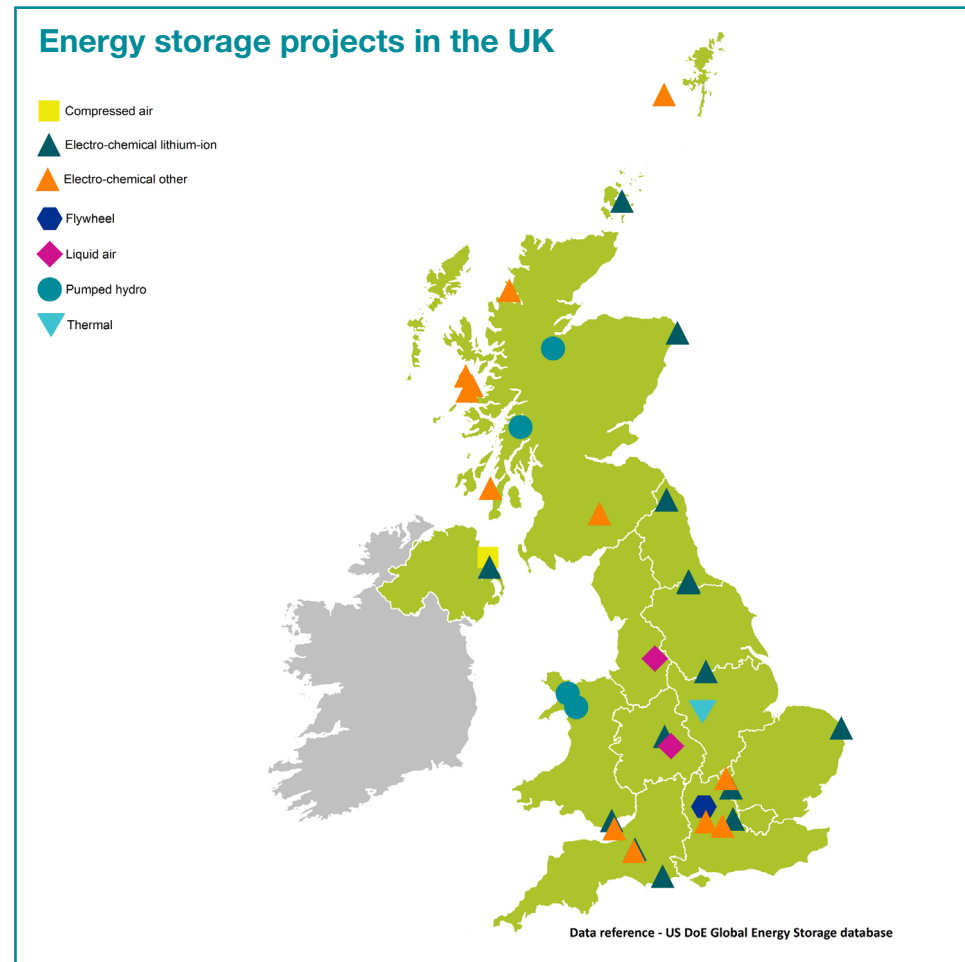

Six projects have been supported by the Ofgem Low Carbon Network Fund, including the 6 MW/10 MWh lithium-ion demonstration storage project being trialled for two years at Leighton Buzzard<sup>12</sup>.

Commercial scale battery storage projects have started to come online, including the AES 10 MW/6 MWh project at Kilroot in Northern Ireland, which it is planned will be built out to a 100 MW array, and the 20 MW RES project, designed in collaboration with National Grid, due for completion by November 2017.

Both these projects are targeting the provision of frequency response services as a high value revenue stream.

<sup>11</sup> Source US Department of Environment – Energy Storage Database Aug 2016 data

<sup>12</sup> Leighton Buzzard – UK Power Networks and partners Smarter Network Storage Project

## The rise of lithium-ion

Lithium-ion costs have fallen rapidly in the last 5 years, in part driven by the growth of motor vehicle applications and a rapid scaling up of manufacturing capability in the US, including Tesla's Giga-factory in Nevada, and LG Chem, Foxconn, BYD and Boston Power in Asia. With the global production of lithium-ion batteries anticipated to triple by 2020, the unit cost is expected to fall by up to two-thirds per kWh from US\$500–700/kWh to US\$200–300/kWh by 2020<sup>13</sup>.

Larger lithium-ion arrays using modular storage units are now the most commonly used solution for projects of 1-20 MW output and up to 2hrs of discharge, especially for rapid response applications. Over 50 per cent of the 32 storage projects commissioned or planned in the UK since 2010 have used lithium-ion batteries . The industry is still in a period of rapid technology development and in the future Flow batteries offering extremely fast charging capability and other electrochemical solutions (sodium and potassium chemistries) offering cheaper, larger storage capacities are expected to be widely available.



<sup>13</sup> Advanced Batteries for Utility Scale Energy Storage, Navigant Research, 2014

<sup>14</sup> Source US Department of Environment – Energy Storage Database Aug 2016 data

## Large scale storage, Compressed Air Energy Storage

As battery storage systems grow, and the tools to integrate and aggregate systems become more sophisticated, there is the potential for batteries to provide larger scale storage capacity.

It will however be a challenge for battery technologies alone to provide the GW scale flexibility that would be required to address the extreme variation in generation and demand that the future UK energy system must accommodate. Larger scale storage solutions, offering >100 MW of power output over an extended period would therefore be a significant contribution to the UK energy mix.

Traditionally pumped hydro schemes have provided large scale storage reservoirs. Newer solutions using subterranean or submarine compressed air – Compressed Air Energy Storage (CAES) – could provide a potential large scale storage solution.

Globally, there are currently six large scale CAES projects<sup>14</sup> (> 100MW power output). This includes the 330 MW Gaelectric project, which has been announced for completion in 2017 using subterranean salt caverns in Larne, Northern Ireland. Further projects have been proposed utilising salt seams in the north west and southern England.

# Projections for energy storage costs

The industry expects that energy storage costs will fall rapidly in the coming years due to a combination of market growth and technology maturity, combined with significant economies of scale in manufacturing and deployment. For example, several recent UK reports have cited analysis from the United States showing a projected 60 per cent fall in lithium-ion battery unit costs from 2014-2020<sup>15</sup>.

While this level of cost reduction for battery units is likely, assuming global market growth and continued scaling up of manufacturing capacity, the impact on the business case for individual energy storage projects will be more complex. The full system cost of individual projects will depend on a wide range of factors and the specific services targeted.

Energy storage cost benchmarks are often presented as a single cost per MW installed or per MWh capacity. However, storage costs are multi-dimensional and so it is worth considering the various cost drivers separately:

- **Power output (MW)** – this will be the key driver of the overall system electrical architecture, power conversion, grid connection and control components
- **Energy storage capacity (MWh)** – this will determine the number and size of the battery units or modules required. Also a key driver of land space and site infrastructure required.
- **Other performance drivers** – the specific system performance requirements of the storage application(s) are key cost drivers, of which the response time, recharge and discharge rates, cycle efficiency and total lifecycles are paramount. For more sophisticated applications, the information and communication technology (ICT) architecture and management tools are critical.

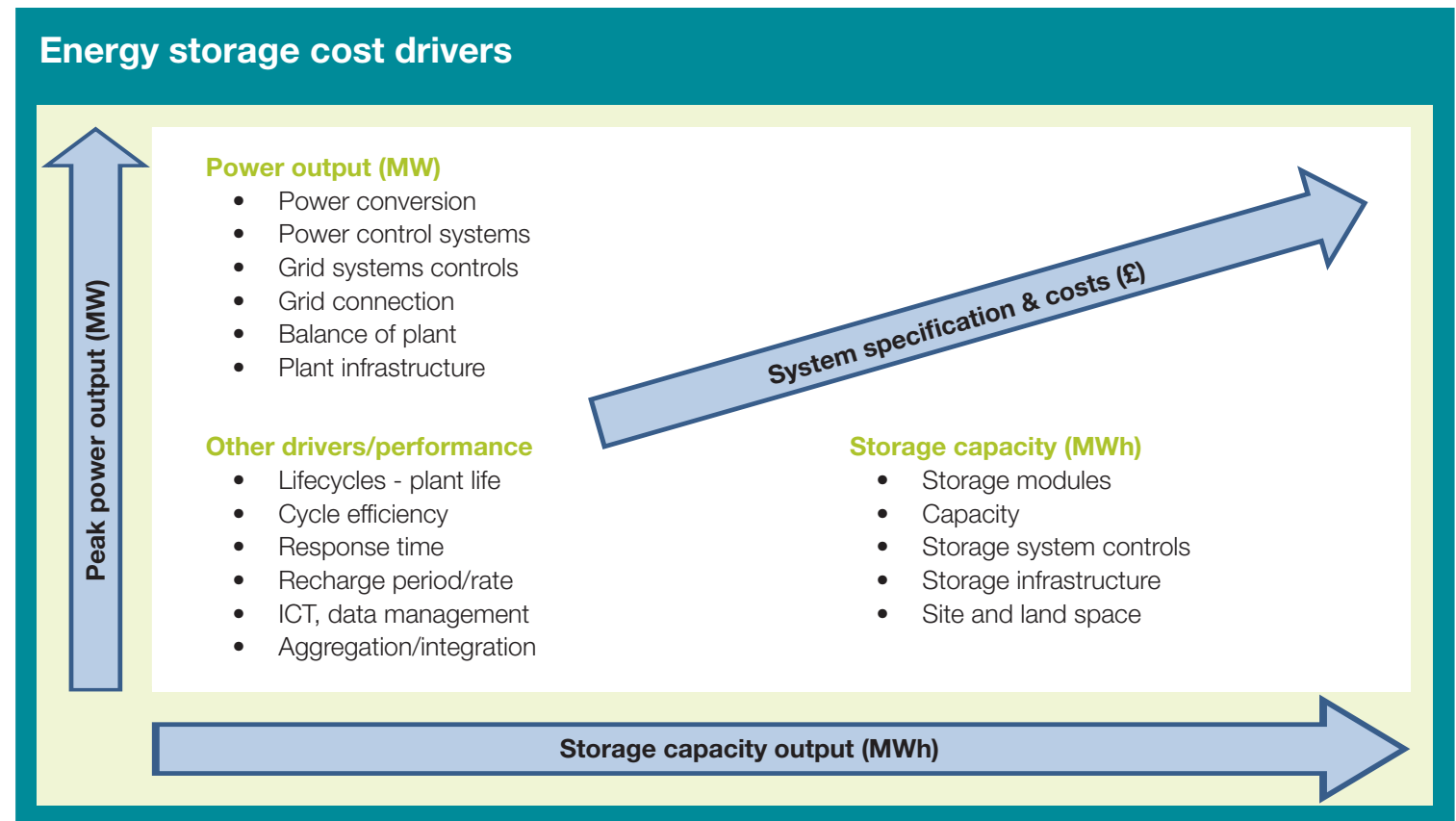

<sup>15</sup>For example Navigant Research (Jaffe and Adamson, 2014) cited in IRENA Battery Storage for Renewables: Technology Status and Market Outlook

## Cost reduction potential – economies of scale and cost reduction over time

Each cost driver will have its own trajectory in terms of cost reduction potential, but as a generalisation those elements that make up the power output components of a battery energy storage system (such as the power conversion, invertors, control systems, grid connections and transformers) tend to have higher economies of scale. Therefore, larger power output systems are expected to be significantly cheaper and will allow step changes in cost per MW.

In contrast, battery units and storage modules, which are the main elements to delivering energy storage capacity (MWh), tend to have lower economies of scale with costs rising broadly in line with capacity.

However, looking at a projection over time, the cost reduction potential is expected to be reversed:

- The main power output components are relatively well established technologies and, whilst costs will continue to fall (particularly for the control systems, ICT and integration technology), the rate of fall is expected to be more modest.
- In contrast, battery storage technology is still a relatively new technology, especially for larger scale applications, and we would expect unit costs to fall quickly as the global market grows through further innovation and growing manufacturing capacity.

These projections are illustrative and generalised, energy storage system costs will vary depending on technology used, individual project specifications, site location and other factors such as the availability of a grid connection.

| Energy storage cost reduction potential                                                                                                                                                                                |                    |                          |
|------------------------------------------------------------------------------------------------------------------------------------------------------------------------------------------------------------------------|--------------------|--------------------------|
|                                                                                                                                                                                                                        | Economies of scale | Cost reduction over time |
| <b>Power output (MW)</b> <ul style="list-style-type: none"> <li>• Power conversion</li> <li>• Power control systems</li> <li>• Grid systems controls</li> <li>• Grid connection</li> <li>• Balance of plant</li> </ul> | <b>Very high</b>   | <b>Medium/high</b>       |
| <b>Storage capacity (MWh)</b> <ul style="list-style-type: none"> <li>• Storage modules</li> <li>• Battery technology</li> <li>• Capacity</li> <li>• Storage system controls</li> </ul>                                 | <b>Medium</b>      | <b>Very high</b>         |
| <b>Site and infrastructure</b> <ul style="list-style-type: none"> <li>• Plant infrastructure</li> <li>• Site and land space</li> </ul>                                                                                 | <b>Medium/high</b> | <b>Low</b>               |



## Current battery storage cost model – powerful economies of scale

The illustrative capital cost model<sup>16</sup> shown in the chart below is for a typical lithium-ion battery system and is based on a number of UK benchmarks and informed by discussion with project and technology developers who have attended Regen SW energy storage forums. An approximate estimate of around £6-7m for a 10MW project with a storage capacity of 10 MWh is a reasonable current UK benchmark.

The cost model illustrates the potential impact of economies of scale: unit costs fall as system size increases. Greater economies of scale are expected to be achieved by increased power output; however, it should be noted that there are very few lithium-ion battery systems over 20 MW currently installed, so this is an extrapolation.

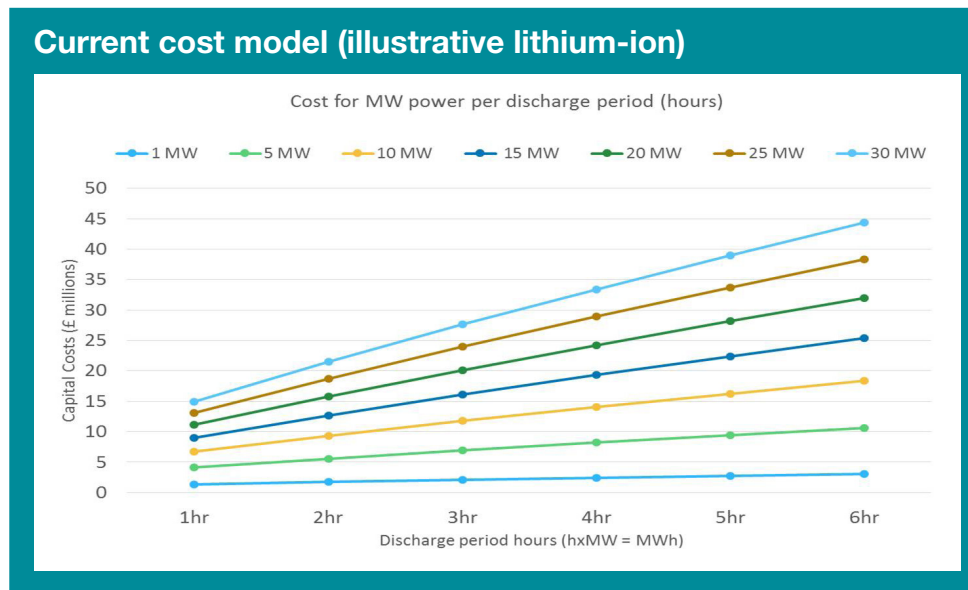

It should be clear from the analysis above that the actual costs of storage projects will depend on a number of factors including the specific performance specification and application for which the storage technology is being used. A further caveat is that economies of scale are likely to exhibit step changes as power levels increase, rather than the smooth cost curve shown.

### Key cost drivers:

- Power output – balance of plant and power control systems, grid connection, ICT
- Capacity Storage – storage units, storage controls
- Site, land space and infrastructure

### Sources of economies of scale:

- Step change in power output, conversion and control systems
- Project development and procurement
- Operating costs (not shown)

One likely implication of this analysis is that current larger battery systems will tend towards a relatively high power/capacity ratio – i.e. towards response type services, delivering megawatt power for shorter periods.

<sup>16</sup> Regen SW Storage Cost model illustrative analysis based on input from developers and technology providers

## Future cost projection model – rapidly falling capacity costs

Over time, it is expected that battery storage costs will “crunch” downwards, as underlying technology costs are reduced and market maturity brings further cost reduction opportunities through a combination of innovation, system integration, component and supply chain efficiencies, standardisation, reduced risk, falling costs of capital, operational efficiencies and the development of better asset management tools.

With high market growth, energy storage costs could demonstrate the exponential cost reduction that has been achieved by solar PV; however, this is less likely to be the case given the greater variety of technology architectures and applications that energy storage will deliver. Nevertheless, a 50 per cent reduction in overall system costs within a 10 year timeframe is possible.

When considering future costs there are a number of factors for energy storage developers to consider:

- System costs are falling rapidly but will continue to vary depending on specific applications.
- It is the combination of power output and energy capacity that determines the overall system scale cost.
- System performance (e.g. response times and recycle rates) will also have a significant impact.





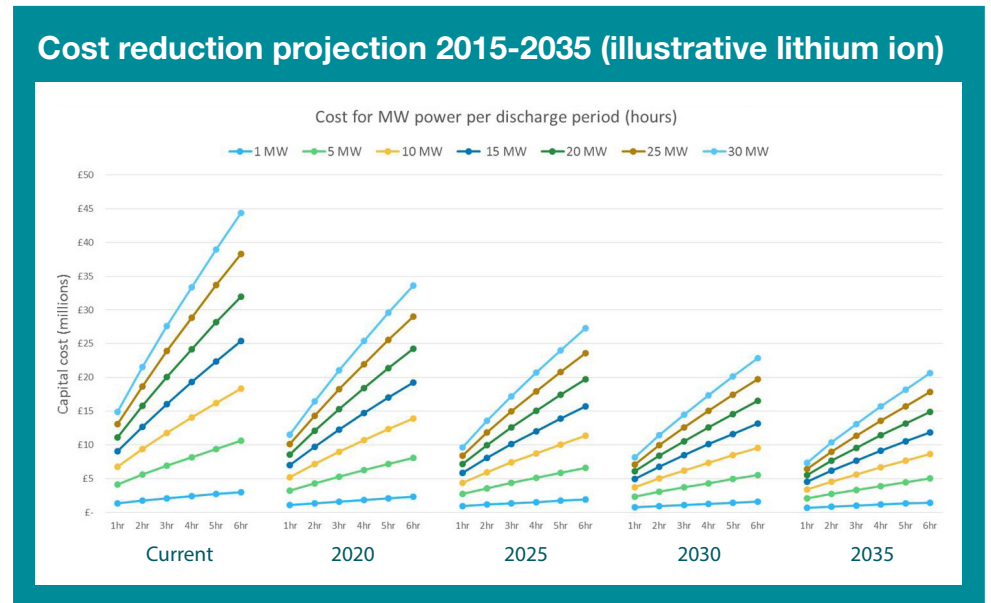





















An implication, which will be discussed in more detail in the following sections, is that combining different revenue streams that require both response and reserve capabilities will likely increase system specification requirements and therefore costs.

So, for example, the cost of a system designed to provide large capacity reserve services over a longer discharge period will be significantly increased if the same system is then also expected to deliver a high power output for a very short time period to deliver response services.





# Potential revenue streams

There are a large number of potential revenue streams that energy storage applications could harness, ranging from relatively high value ancillary services to improve power quality, to reserve capacity services and time/price shift applications. Combining several revenue streams, utilising the full value proposition and functionality of energy storage, could be a strategy to build an attractive business case. The challenge is to find the right combination of revenue streams that are compatible (technically, regulatory and commercially) and are sustainable in the longer term.

|                  | Major revenue stream                                          | Route to market                                                 | Relative value | Market size* | Location options                                                                                                                                                                                                                                                                                                                                        |
|------------------|---------------------------------------------------------------|-----------------------------------------------------------------|----------------|--------------|---------------------------------------------------------------------------------------------------------------------------------------------------------------------------------------------------------------------------------------------------------------------------------------------------------------------------------------------------------|
| Response         | Enhanced Frequency Response                                   | Tender (Auxiliary service)                                      | High           | 200-700 MW   |                                                                                                                                                                                   |
|                  | Firm Frequency Response (generation or demand reduction)      | Tender (Auxiliary service)                                      | High           | 2000-3000 MW |                                                                                                |
|                  | Frequency Control by Demand Management (FCDM)                 | Tender (Auxiliary service)                                      | Med/high       | ??           |                                                                                                                                                                                                                                                                      |
|                  | Fast Reserve                                                  | Tender (Balancing service)                                      | Med/high       | 250-600 MW   |                                                                                                |
| Reserve          | Consumer backup power                                         | Contract                                                        | Variable       | ??           |                                                                                                                                                                                                                                                                      |
|                  | Short Term Operating Reserve (generation or demand reduction) | Tender (Balancing service)                                      | Med            | 2-4 GW       |                                                                                                |
|                  | Capacity Market                                               | Tender - Capacity Auction                                       | Med            | GWs          |                                                                                                                                                                                   |
|                  | Transmission cost avoidance                                   | Market mechanism/cost avoidance                                 | Med/high       | GWs          |                                                                                                                                                                                 |
| Time/price shift | Distribution cost avoidance                                   | Market mechanism/cost avoidance                                 | Med/high       | GWs          |                                                                                                                                                                               |
|                  | Generator "Own Use" (Domestic and non-domestic)               | Market via price/cost avoidance                                 | Low            | GWs          |                                                                                                                                                                               |
|                  | Generator grid curtailment                                    | Market via price & subsidy revenue gain/reinforcement avoidance | Low/mid        | GWs          |                                                                                                                                                                               |
|                  | Price arbitrage (& peak shaving)                              | Market via price variance/trade                                 | Low            | GWs          |     |

 Transmission grid connected

 Distribution grid connected

 Potential demand side response or behind the meter

 Co-location with renewables benefits

Table adapted from a number of sources including National Grid Future Energy Scenarios 2016

- High response services, dynamically delivering real-time energy within seconds or mill-seconds, generate the highest relative value and have attracted the most commercial interest. But, these services require a high degree of system performance and offer a smaller (potentially more competitive) market compared to the larger scale reserve and time/price shift services.
- Fast Reserve is potentially high value, but is a limited market with a small number of providers.
- STOR and Capacity Markets offer a relatively low return but allow for slower response times, and may be more compatible with other services.
- Transmission and distribution cost avoidance are potentially very attractive revenue streams, but future charging structures may change.

\* The market size range estimate for auxiliary and balancing services are based on the recent capacity volumes procured by National Grid 2015/16 taken from the National Grid market analysis reports March 2016, plus an estimate of potential growth.

# Potential revenue streams

| Enhanced Frequency Response (EFR)                                                                                                                                                                                                                                                                                                                                                                                                                                                                                                                                                                                              | Firm Frequency Response (FFR)                                                                                                                                                                                                                                                                                                                                                                                                                                                                                                                                                              | Fast Reserve                                                                                                                                                                                                                                                                                                                                                                                                                                                                                                                                                                                   | Short Term Operating Reserve                                                                                                                                                                                                                                                                                                                                                                                                                                                                                                                                                                                         | Capacity Market                                                                                                                                                                                                                                                                                                                                                                                                                                                                                                                                                                                                                                             |
|--------------------------------------------------------------------------------------------------------------------------------------------------------------------------------------------------------------------------------------------------------------------------------------------------------------------------------------------------------------------------------------------------------------------------------------------------------------------------------------------------------------------------------------------------------------------------------------------------------------------------------|--------------------------------------------------------------------------------------------------------------------------------------------------------------------------------------------------------------------------------------------------------------------------------------------------------------------------------------------------------------------------------------------------------------------------------------------------------------------------------------------------------------------------------------------------------------------------------------------|------------------------------------------------------------------------------------------------------------------------------------------------------------------------------------------------------------------------------------------------------------------------------------------------------------------------------------------------------------------------------------------------------------------------------------------------------------------------------------------------------------------------------------------------------------------------------------------------|----------------------------------------------------------------------------------------------------------------------------------------------------------------------------------------------------------------------------------------------------------------------------------------------------------------------------------------------------------------------------------------------------------------------------------------------------------------------------------------------------------------------------------------------------------------------------------------------------------------------|-------------------------------------------------------------------------------------------------------------------------------------------------------------------------------------------------------------------------------------------------------------------------------------------------------------------------------------------------------------------------------------------------------------------------------------------------------------------------------------------------------------------------------------------------------------------------------------------------------------------------------------------------------------|
| <p>Similar to FFR but a faster response service to provide sub-second frequency response services.</p> <p>Service specifically targeted at battery storage providers with a high response capability.</p> <p>National grid tender for 200 MW announced in August 2016 that 8 EFR bidders had been awarded 4 year contracts using battery storage.</p> <p>Further tenders are expected.</p> <p>No aggregation.</p> <p>Pre-tender speculation suggested rates of between £20 and £40 per MW per hour of service.</p> <p>Auction outcome was however lower at an average of £9.40 per MW per hour with a range from £7-£11.97</p> | <p>Service to maintain overall grid frequency within a tolerance range of 50Hz. Service may be dynamic (constantly responsive) or static (trigger response).</p> <p>Service is tendered on a monthly basis and rates vary depending on service level, of which there are several.</p> <p>Short term tenders – 1-23 months although most &gt; 6 months.</p> <p>Suitable for battery applications, response within 10 sec (primary) or 30 sec (secondary) and sustained for up to 30 mins.</p> <p>10 MW minimum but can be aggregated.</p> <p>Potential also for Demand Response - FCDM.</p> | <p>Fastest reserve service, 2 minute response to unexpected demand increase or loss of generation. Service utilisation for a up to 15 min (or as specified) unit but generally &lt;5 minutes</p> <p>Contract duration 1-23 month (can be up to 10 years) but typically &lt; 6 months.</p> <p>Morning and evening availability. Minimum capacity 50 MW but aggregation is possible through an integrator.</p> <p>Relatively small market and few current providers.</p> <p>Complex payments for availability, positional, nomination and utilisation.</p> <p>Potential for Demand Response.</p> | <p>Short term and a slower reserve service.</p> <p>3 MW minimum but typically 10-15MW.</p> <p>Ramp up within 20 mins desirable to win contract, typically asked to maintain energy output for a minimum of 2 hours and a recovery within 20 hours.</p> <p>3 seasonal auctions, seasonal &amp; daily time periods.</p> <p>Payments for availability £/MW/hr and utilisation £/MWh. Prices and revenues have been falling suggested increased competition. Revenue is uncertain depending on availability and utilisation.</p> <p>Competitive threat from diesel generators.</p> <p>Potential for Demand Response.</p> | <p>The Capacity Market instrument to secure existing, and incentivise, new capacity to maintain capacity margins. In return for capacity payment revenue, generators must be available to deliver energy at times of peak demand or system stress.</p> <p>Annual auction tender for future years capacity. Duration varies – longer for new capacity.</p> <p>UK 2015 T4 tender for 2019/20 lower than expected at only £18 per KW.</p> <p>The pre-qualification for the 2016 T4 tender has been announced and includes over 4 GW of storage capacity of which over 2 GW is new build battery storage.</p> <p>Competitive threat from diesel generators.</p> |
| Relative value – High                                                                                                                                                                                                                                                                                                                                                                                                                                                                                                                                                                                                          | Relative value - High                                                                                                                                                                                                                                                                                                                                                                                                                                                                                                                                                                      | Relative value – Med/high                                                                                                                                                                                                                                                                                                                                                                                                                                                                                                                                                                      | Relative value - Med                                                                                                                                                                                                                                                                                                                                                                                                                                                                                                                                                                                                 | Relative value – Med                                                                                                                                                                                                                                                                                                                                                                                                                                                                                                                                                                                                                                        |
| Based on 2016 EFR auction outcome: annual Revenue £60-£105k per MW per year                                                                                                                                                                                                                                                                                                                                                                                                                                                                                                                                                    | Varies according to service. Rough estimate £40-150k per MW per year depending on service and hours tendered.                                                                                                                                                                                                                                                                                                                                                                                                                                                                              | <p>Difficult to estimate for a storage provider new entrant.</p> <p>Very rough revenue estimate £50-70k per MW per year based on analysis of National Grid 2015/16 market data.</p>                                                                                                                                                                                                                                                                                                                                                                                                            | <p>Combined annual potential revenues circa £20-35k per MW per annum (assuming availability).</p> <p>Based on 2014/15 and 2015/16 total STOR expenditure Ref National Grid Service Reports</p>                                                                                                                                                                                                                                                                                                                                                                                                                       | <p>£20-35k per MW per year, possibly higher, depending auction* outcomes.</p> <p>*UK 2016 T4 (Dec) tender price is expected to be higher than 2015</p>                                                                                                                                                                                                                                                                                                                                                                                                                                                                                                      |

Note: There are numerous information sources for National Grid Auxiliary and Balancing Services including the Service Guides and Market Information reports which can be found on the Balancing Services section of the National Grid website. The “ballpark” revenue estimates presented here are averages based on current average service tariffs and overall National Grid service expenditure as reported in its monthly and annual service reports. Actual revenue will depend on tender outcomes, asset availability and actual utilisation which will in turn depend on a number of factors and could vary considerably.

| Transmission cost avoidance                                                                                                                                                                                                                                                                                                                                                                                                                                                                                                                                                                                                                                                  | Distribution cost avoidance                                                                                                                                                                                                                                                                                                                                                                                                                                                                                                                                                             | Generator “own use”<br>(domestic and non-domestic)                                                                                                                                                                                                                                                                                                                                                                                                                                                                                                                                                                            | Generator Grid Curtailment                                                                                                                                                                                                                                                                                                                                                                                                                                                                                                                               | Price arbitrage<br>(& peak shaving)                                                                                                                                                                                                                                                                                                                                                                                                                                                                                                       |
|------------------------------------------------------------------------------------------------------------------------------------------------------------------------------------------------------------------------------------------------------------------------------------------------------------------------------------------------------------------------------------------------------------------------------------------------------------------------------------------------------------------------------------------------------------------------------------------------------------------------------------------------------------------------------|-----------------------------------------------------------------------------------------------------------------------------------------------------------------------------------------------------------------------------------------------------------------------------------------------------------------------------------------------------------------------------------------------------------------------------------------------------------------------------------------------------------------------------------------------------------------------------------------|-------------------------------------------------------------------------------------------------------------------------------------------------------------------------------------------------------------------------------------------------------------------------------------------------------------------------------------------------------------------------------------------------------------------------------------------------------------------------------------------------------------------------------------------------------------------------------------------------------------------------------|----------------------------------------------------------------------------------------------------------------------------------------------------------------------------------------------------------------------------------------------------------------------------------------------------------------------------------------------------------------------------------------------------------------------------------------------------------------------------------------------------------------------------------------------------------|-------------------------------------------------------------------------------------------------------------------------------------------------------------------------------------------------------------------------------------------------------------------------------------------------------------------------------------------------------------------------------------------------------------------------------------------------------------------------------------------------------------------------------------------|
| <p>The cost of UK transmission network is charged to generators and demand users via a number of mechanisms.</p> <p>Demand based charges (73% of total charges) are mainly recovered through the Transmission Network Use of System (TNUoS) &amp; Balancing Services Use of System (BSUoS).</p> <p>Both are based on peak time demand – for TNUoS this is calculated using the “TRIAD” peak demand periods.</p> <p>There is a value in using storage to reduce net demand during the peak time &amp; TRIAD periods to avoid these charges. Revenue could come in the form of payments from energy off-takers (“Embedded Benefits”) or cost saving for high energy users.</p> | <p>The cost of running the distribution network is recovered from generators and demand users.</p> <p>Energy storage and distributed generators can therefore offset demand earning a credit from DNO’s, or offsetting high energy users costs.</p> <p>For intermittent generation the credit is a flat rate, for non-intermittent the credit is time banded and are highest during the peak demand period “Red Zone” (4-7pm daily) and in the winter period “Super Red Zone”.</p> <p>The value is greatest if connected at the Low Voltage network and varies (greatly) by region.</p> | <p>Located alongside variable generation such as PV and wind, energy storage could be used to store energy during peak generation periods and deliver energy during periods of user demand.</p> <p>Value for the energy user comes from maximising their own use of generated electricity, avoiding the peak price for electricity during high demand periods.</p> <p>An example would be charging batteries linked to solar PV during the day, and time shifting the energy to the early evening peak when costs are highest. This will be facilitated by the roll-out of smart meters and “time of use” tariffs (TouT).</p> | <p>Energy storage could be used to store, and time shift energy which would otherwise be “lost” due to grid curtailment.</p> <p>This opportunity has grown due to the increase in constraints in the distribution network especially in high renewable energy regions and the increase in constrained grid connection offers.</p> <p>An alternative value would be avoidance of grid reinforcement.</p> <p>This could potentially be combined with an “own use” high energy user or as a standalone application co-located with an energy generator.</p> | <p>Although co-location alongside energy generation and a high energy users would deliver greater value, it is also possible that energy storage could be used simply to exploit price variance in the energy market.</p> <p>Storing energy during low price periods for delivery during peak price periods.</p> <p>Wholesale price variance in the UK ranges from &lt;£20 MWh during low demand periods to £80 MWh plus during the peak.</p> <p>Extremes of negative pricing and very high spot prices have also become more common.</p> |
| Relative value – Med/high                                                                                                                                                                                                                                                                                                                                                                                                                                                                                                                                                                                                                                                    | Relative value - High                                                                                                                                                                                                                                                                                                                                                                                                                                                                                                                                                                   | Relative value – Low                                                                                                                                                                                                                                                                                                                                                                                                                                                                                                                                                                                                          | Relative value - Low                                                                                                                                                                                                                                                                                                                                                                                                                                                                                                                                     | Relative value – Low                                                                                                                                                                                                                                                                                                                                                                                                                                                                                                                      |
| <p>Potentially a good revenue stream especially if the TRIAD periods are successfully targeted.*</p> <p>Together TNUoS, BSUoS and transmission loss embedded benefits or cost savings could be worth £40-50k per MW per year.</p>                                                                                                                                                                                                                                                                                                                                                                                                                                            | <p>Potentially attractive. depending on location and how energy storage is treated by DNO’s*.</p> <p>Potentially £40-80k per MW per year in south west England however see note below.</p>                                                                                                                                                                                                                                                                                                                                                                                              | <p>Low relative value because a relatively high storage capacity is required to store variable generation and capture revenue from daily price variance between wholesale and retail tariff.</p>                                                                                                                                                                                                                                                                                                                                                                                                                              | <p>Combined with own use would deliver higher value but a relatively high storage capacity (and therefore capital cost) is needed to meaningfully time shift generation.</p>                                                                                                                                                                                                                                                                                                                                                                             | <p>The challenge for energy storage is the capital investment required to store significant energy capacity to effectively price arbitrage.</p>                                                                                                                                                                                                                                                                                                                                                                                           |
| <p>*Note: The mechanism to recover transmission costs is expected to be overhauled and the future of TRIADs is uncertain – see “Paying for our grid”</p>                                                                                                                                                                                                                                                                                                                                                                                                                                                                                                                     | <p>*Note: changes in the way DNUoS charges are calculated will significantly reduce peak time cost savings from 2018 onwards.</p>                                                                                                                                                                                                                                                                                                                                                                                                                                                       |                                                                                                                                                                                                                                                                                                                                                                                                                                                                                                                                                                                                                               |                                                                                                                                                                                                                                                                                                                                                                                                                                                                                                                                                          |                                                                                                                                                                                                                                                                                                                                                                                                                                                                                                                                           |

Note: further details on the Transmission charging regime can be found on the National Grid website under “Electricity Connection System Charges”

# Paying for the grid – electricity network charging for a flexible future

By providing flexibility, energy storage will reduce the overall capacity and infrastructure required to deliver the variable energy that the UK requires, and could significantly reduce the cost of operating the grid transmission and distribution networks. Therefore, it is reasonable to expect that the contribution storage provides in reducing grid costs should provide developers with a long term revenue stream. Unfortunately, at a time when storage investors are looking to create a viable business case, the underlying basis of grid charging is coming under review by Ofgem<sup>17</sup>. Although the outcome of this review is uncertain, it could have a profound impact on the viability of energy storage and other forms of flexible energy technologies.

The UK grid charging regime is complex and has not been designed for a future, more decentralised energy market. There is now a general acceptance that the regime should be simplified, if not completely overhauled, to reduce the impact of market distortions and encourage the most efficient use of the networks.

Many would also argue that the charging principles also need to be redefined to reflect new energy priorities and changing market structures. Following a number of industry studies, Ofgem<sup>17</sup> has indicated that the level of distortion and imperfection in the charging regime needs to be urgently addressed.

Specifically, Ofgem has identified that the demand component of transmission charging, and the associated opportunity to earn “embedded benefits” by avoiding these costs, may be over rewarding generators connected to the distribution network.

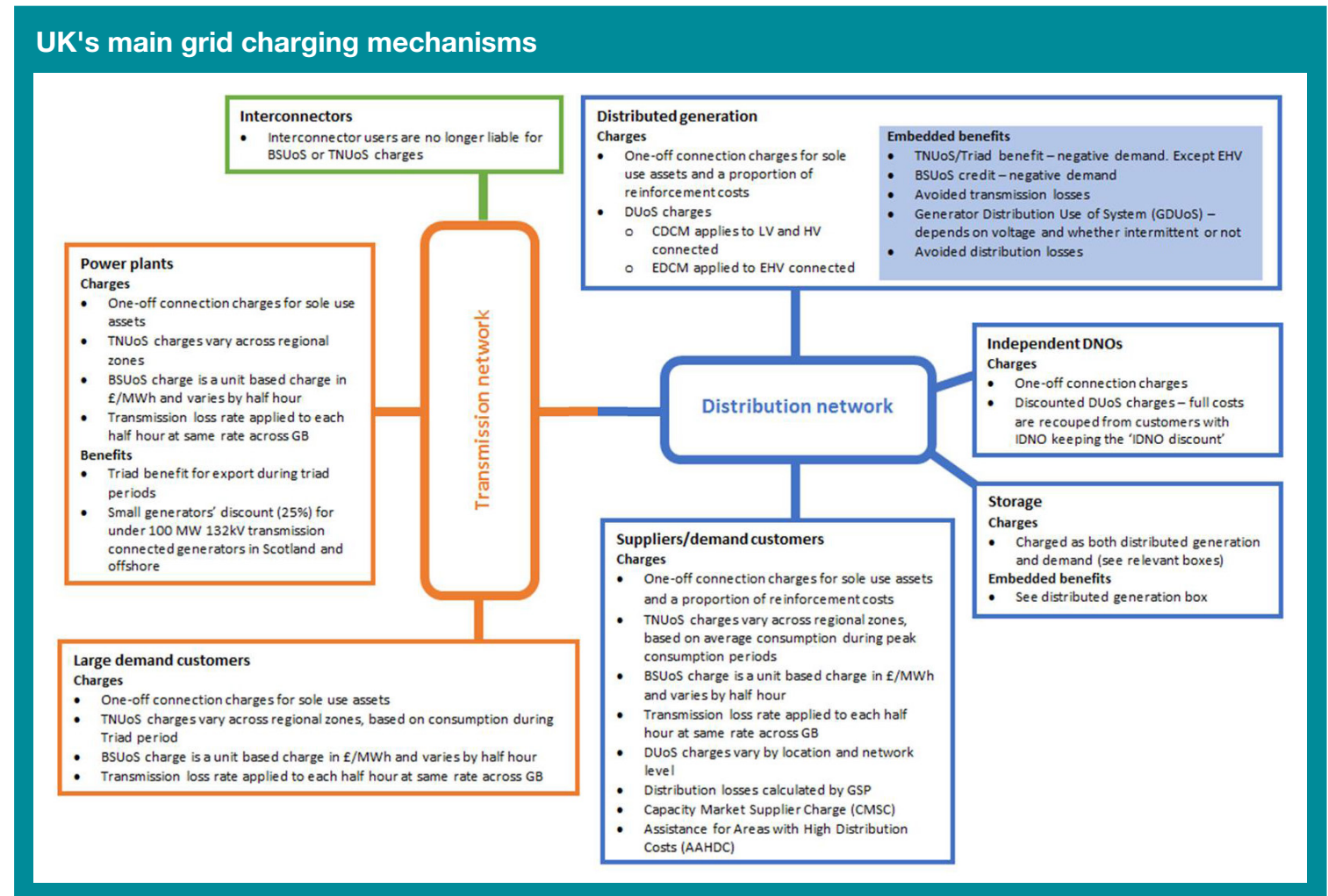

<sup>17</sup> Ofgem open letter “Charging arrangements for embedded benefits” 29 July 2016

The knock on impact of this could herald the so-called “death spiral of the grid” phenomena, as more generators and high energy users effectively avoid paying grid transmission charges, leaving those grid users who remain to pay ever increasing costs. There are a number of short and longer term changes that could be enacted to address this issue, ranging from a complete change to the basis of charging to a number of smaller adjustments.

Each change will have impacts; for example, one option might be to reduce the demand portion of network charging by placing a higher proportion of network costs onto generators. But, in an integrated European energy market, linked by interconnectors this could add further cross-border distortion. This is one reason why under EU rules there is a maximum €2.50 per MWh cap on transmission network charges made to generators.

The value of transmission embedded benefits or cost avoidance could be worth up to £40-50k per MW per year for an energy storage provider, and was expected to rise to circa £60-80k per MW per year by 2020/21 in line with higher half hour demand tariffs<sup>18</sup>. While not targeting energy storage in particular, the unintended consequence of a change in the way charges are levied could be to reduce the viability of energy storage projects.

Depending on the nature of the changes that are adopted, they may not immediately impact “behind the meter” models. Ofgem has, however, also given notice that they are aware that the number of “behind the meter” systems has increased and that they will also be looking at this issue in relation to grid charging in the near future.

Following Ofgem’s call for evidence, Regen SW has now issued a response paper, “Electricity Charging for a Flexible Future”<sup>19</sup>, which asks Ofgem to take a more holistic approach and consider the wider impacts of any changes to the grid charging review.

As well as supporting innovation and the development of new technologies, the paper makes the case for a full strategic review of grid charging to ensure that it is appropriate for the UK’s future energy system and supports greater levels of energy flexibility through energy storage, demand side response and local network balancing. The Association for Decentralised Energy has also issued a response backed by analysis compiled by Cornwall Energy<sup>20</sup>.

In a discussion blog “A short term fix for the UK Capacity Market must not derail investment in a smarter low carbon energy future”<sup>21</sup>, Regen strongly argues that Ofgem and BEIS must consider the wider impacts of network charging policies before making short term fixes.

In response to the BEIS/OFGEM call for evidence Regen SW and the industry will be putting forward a strong argument that the underlying value of energy storage to reduce network cost and infrastructure investment should be recognised and monetarised as a source of revenue, but, until the future charging mechanism is defined, the revenue streams in this paper related to both transmission and distribution grid cost avoidance must be viewed with caution.

<sup>18</sup> Analysis using National Grid Forecast TNUoS Tariffs 2016/17-2020/21 Feb 2016. Assuming successful targeting of TRIADs and peak pricing periods

<sup>19</sup> Regen SW - Electricity Charging for a Flexible Future Sept 2016

<sup>20</sup> Cornwall Energy: A Review of the Embedded Benefits accruing to Distribution Connected Generation in GB May 2016

<sup>21</sup> Regen SW - A short term fix for the UK Capacity Market must not derail investment in a smarter low carbon energy future – November 2016

# Building a sustainable business case

At a time when many energy generation projects are being impacted by subsidy cuts, the wide range of energy storage revenue streams available presents a tempting smorgasbord for an investor looking for new opportunities. This commercial interest is evidenced by the surge in grid connection applications received by Distributed Network Operators (DNOs) for storage projects.

Although the volume of applications is not necessarily an indication of the true market potential; and may in part be symptomatic of developers with limited information trying to ascertain where on the network they can get a low-cost connection agreement, the numbers do indicate that there is an investor appetite for energy storage projects and that there are already a number of potentially viable business models in which to invest.

Combining revenue streams to create a business case for the term of an energy storage project is difficult and presents a number of challenges. For any developer coming to energy storage with a renewable generation project background, there are a number of elements to consider:

|                                                                |                                                                                                                                                                                                                                                                                                                                                                                                                                                                                                                                                             |
|----------------------------------------------------------------|-------------------------------------------------------------------------------------------------------------------------------------------------------------------------------------------------------------------------------------------------------------------------------------------------------------------------------------------------------------------------------------------------------------------------------------------------------------------------------------------------------------------------------------------------------------|
| <b>Regulatory constraints and policy change</b>                | The current regulatory and policy framework has not been designed for energy storage. Even the definition of how storage should be treated (as an intermittent generation or demand asset) needs to be clarified as soon as possible.                                                                                                                                                                                                                                                                                                                       |
| <b>Commercial risk and speculation</b>                         | As with any new market, the industry faces a number of commercial risks, including the potential of the market for new storage services becoming over-heated in the short term, leading to higher costs, unsustainable competition and unrealistic auction outcomes. Competition will come not only from other storage providers, but also from diesel and other generators.                                                                                                                                                                                |
| <b>Revenue risk – timing, degradation and uncertainty</b>      | Without the benefit of long term fixed price contracts, akin to those offered by Contracts for Difference in the generation market, storage investors must look to combine successive revenue streams over time to create a sustainable business case. With increased competition through auctions and marginal cost pricing, combined with falling technology costs, there is the potential that revenues will degrade or be cannibalised over time. This is especially a risk for those, higher value, services that have a smaller or fixed market size. |
| <b>Technical complexity performance, and operability risks</b> | In the short term at least, energy storage projects will require a higher degree of system architecture design and will carry higher levels of technology risk than more established generation technologies. Combining revenue streams – with potentially different or even conflicting requirements – will further increase system complexity and the need for greater control and management systems integration.                                                                                                                                        |
| <b>Environmental, safety and ethical risks</b>                 | As with any high growth technology, the energy storage sector needs to be mindful that it applies the highest environmental, employment, safety and ethical standards.                                                                                                                                                                                                                                                                                                                                                                                      |



While recognising that there are risks and challenges, it is significant that there are a number of commercial projects in development, and that the industry is actively seeking ways to create sustainable business cases for energy storage investments.

In the analysis below, we consider a few of the most likely business models that combine, or have the potential to combine, several revenue streams. This is not intended to be an exhaustive list and there are other potential combinations that could be the basis of a viable business case. For clarity, we have characterised and labelled each business model based on a primary revenue stream.

## New and emerging business models

- **Response service** – based primarily on providing higher value frequency response services to the grid networks, but potentially time-sharing this with transmission and distribution network cost avoidance during TRIAD and “Red Zone” peak cost periods.
- **High energy user – cost avoidance** – “behind the meter” located with an industrial/commercial energy user, primarily to avoid peak energy retail, transmission and distribution costs
- **Domestic and community** – Utilising storage with rooftop PV generation to maximise “own use” energy and avoid higher retail prices. Potentially aggregated to maximise own use across a local network and linked to Time of Use (ToUT) tariffs
- **Energy reserve** – providing reserve energy via Fast Reserve, STOR and/or Capacity Market mechanisms for contracted time periods. Potentially combined with network cost avoidance and other services.
- **Energy trader** – Energy supply company, local supply market or generator using storage as a means of arbitrage between low and high price periods. Potentially aggregated.

## Energy Storage Potential Business Models (examples)

|                                                                                                                                                                                                                                                                           | Response Service                    | High energy user - cost avoidance      | Domestic and community           | Energy reserve                           | Energy trader                    |
|---------------------------------------------------------------------------------------------------------------------------------------------------------------------------------------------------------------------------------------------------------------------------|-------------------------------------|----------------------------------------|----------------------------------|------------------------------------------|----------------------------------|
| Primary service                                                                                                                                                                                                                                                           | Enhanced Frequency Response* or FFR | Transmission cost avoidance            | Generator "own use"              | STOR* or Fast Reserve or Capacity Market | Price arbitrage and peak shaving |
| Additional revenue(s)                                                                                                                                                                                                                                                     | Firm Frequency Response             | Distribution cost avoidance            | Aggregated "own use"             | Transmission cost avoidance              | Aggregated price arbitrage       |
|                                                                                                                                                                                                                                                                           | Transmission cost avoidance         | Peak shaving                           | Price arbitrage and peak shaving | Distribution cost avoidance              | Grid curtailment                 |
|                                                                                                                                                                                                                                                                           | Distribution cost avoidance         | Frequency control by demand management | Grid curtailment                 | Price arbitrage and peak shaving         |                                  |
|                                                                                                                                                                                                                                                                           | Capacity market**                   | Generator "own use"                    | Frequency Response*              |                                          |                                  |
|                                                                                                                                                                                                                                                                           |                                     | Backup                                 | STOR* or Capacity Market         |                                          |                                  |
| <p>* Note: there are timing constraints which would prevent several grid response and reserve services being provided simultaneously, so different service time periods would be required.<br/> ** If frequency response is defined as a “relevant balancing service”</p> |                                     |                                        |                                  |                                          |                                  |

## Response service

The “response service” business model is based on providing high value, rapid response services to grid operators. These services require high performance storage systems with second, or sub-second, response times and real-time dynamic controls to respond to frequency variations within a range around 50Hz. Power is delivered for short durations (typically 5-30 mins), so response systems can be designed to provide relatively high power output with a limited storage capacity – for example 10-20 MW power output with 6-10MWh capacity. The two main services, Enhanced Frequency Response (EFR) and Firm Frequency Response (FFR) offer potentially high value revenue streams (depending on the service level offered and the hours tendered) that could form the foundation for a viable storage business case.

### Enhanced Frequency Response – high service (sub second) and higher value contracts

EFR requires rapid response in less than one second. The first tender for this service was completed in August 2016. The overwhelming majority of bids were from energy storage projects and the tender resulted 8 four year contracts being awarded. The final tender price which averaged £9.44 per EFR MW<sup>22</sup> per hour was lower than had been expected, giving an annual revenue range of £60-105k per MW per year.

| Provider              | Site Location/ Name | Service Type | Provider Type | Enhanced Response (MW) | Estimated Start Date | Total Cost of tender £m | GWh of EFR holding | Service Hours | Average price of tender £/MW of EFR/h | Does tender exclude typical TRIAD hours |
|-----------------------|---------------------|--------------|---------------|------------------------|----------------------|-------------------------|--------------------|---------------|---------------------------------------|-----------------------------------------|
| EDF Energy Renewables | T-WBURB-4           | Service 2    | Storage       | 49                     | Dec-17               | £12.035                 | 1719.312           | 35088         | £7.00                                 | FALSE                                   |
| Vattenfall            | Pen Y Cymoedd       | Service 2    | Storage       | 22                     | Apr-17               | £5.749                  | 771.936            | 35088         | £7.45                                 | FALSE                                   |
| Low Carbon            | Cleator             | Service 2    | Storage       | 10                     | Dec-17               | £2.681                  | 337.6              | 33760         | £7.94                                 | TRUE                                    |
| Low Carbon            | Glassenbury         | Service 2    | Storage       | 40                     | Mar-18               | £12.668                 | 1350.56            | 33764         | £9.38                                 | TRUE                                    |
| E.ON UK               | Sheffield           | Service 2    | Storage       | 10                     | Nov-17               | £3.891                  | 350.88             | 35088         | £11.09                                | FALSE                                   |
| Element Power         | TESS                | Service 2    | Storage       | 25                     | Feb-18               | £10.079                 | 877.2              | 35088         | £11.49                                | FALSE                                   |
| RES                   | RESEFR7-PT          | Service 2    | Storage       | 35                     | Feb-18               | £14.651                 | 1228.08            | 35088         | £11.93                                | FALSE                                   |
| Belectric             | Nevedon             | Service 2    | Storage       | 10                     | Oct-17               | £4.200                  | 350.88             | 35088         | £11.97                                | FALSE                                   |
| <b>Total</b>          |                     |              |               | <b>201</b>             |                      | <b>£65.954</b>          |                    |               | <b>£9.44</b>                          |                                         |

Source: National Grid EFR Tender Results<sup>22</sup>

### Firm Frequency Response – regular short term contracts allowing lower service and aggregation

FFR has a slightly slower response time requirement. Tendered monthly for short term contracts of 1-6 months (although it is possible to bid for a longer contract), FFR could be a useful follow-on or alternative revenue stream to EFR and potentially offers more flexibility to combine with other services. FFR also allows for aggregation and has a demand response counterpart – Frequency Control by Demand Management (FCDM). Both these services are ideally suited to battery storage technology and it is significant that early commercial projects, such as the AES Kilroot project in Northern Ireland, and the recently announced RES National Grid storage project, are targeting frequency response as their main revenue stream. It is not possible to offer other services during the contracted FFR and EFR service periods and there are penalties if the agreed service levels are not maintained. Providers of both FFR and EFR can, however, offer time specific “availability windows” and it would therefore be possible to exclude part of the peak demand period of 4-7 pm to allow transmission and distribution cost avoidance, and price arbitrage. Two of the winning tenders for EFR choose to exclude Triad periods, although a further 6 bidders who planned the same approach choose to withdraw their tender in light of Ofgem’s “Open Letter on Embedded Benefits”.

<sup>22</sup> National Grid – Enhanced Frequency Report Market Information report 26th August 2016

## Enhanced Frequency Response Tender Outcome August 2016

The results of the first National Grid EFR auction were published on 26th August and can be found on the National Grid website. Successful bidders in the £65 million tender now have 18 months to complete their projects but already the tender results have revealed some very interesting energy storage market trends.

### 1. Energy storage dominated the tender.

From the first round of submissions and through pre-qualification battery energy storage dominated the tender process and so it was no surprise that the eight contract awards, totalling just over 200 MW went to storage providers. Of the 37 organisations that submitted final tenders almost all proposed storage solutions, accounting for 61 out of 64 site applications, the only exceptions being Drax Power Ltd and a couple of demand response aggregators. This suggests that the market interest in energy storage is extremely strong and there are a significant number of companies who have seen a commercial opportunity in this area.

### 2. Established and larger utilities were extremely active.

The pattern of bids suggests a determination on the part of existing utilities to establish themselves in the storage market. EDF Energy Renewables, Vattenfall, E.ON UK and RES all picked up contracts accounting for 116 MW, while losing bids also came from RWE, Centrica and SSE. Alongside the utilities and energy generation companies, the tender featured a number of relatively new companies and storage specialists.

### 3. The final bid prices were lower than had been anticipated.

The pre-tender speculation suggested that the price paid for EFR services, given its sub-second response requirements, would be higher than that paid for its more established cousin, Firm Frequency Response. That would suggest a price potentially higher than £20 per MW per hour, although heightened market interest and the offer of a four year contract might have suggested a winning outcome closer to £15 per MW per hour. In fact the tender outcome produced winning bids in the range of £7 to £11.97 per MW per hour, although the overall average bid across all 203 bid submissions was just over £21 per MW per EFR hour.



## High energy user – “behind the meter” model

A “behind the meter” energy storage project, co-located with a high energy user or private wire network, possibly also co-located with renewable generation, could already form the basis of a viable business case, in terms of revenue or cost saving opportunities. This model also has the advantage of providing inherent cost reduction value to an end customer, which, although it may be impacted by regulatory uncertainty, is likely to provide a degree of long term revenue security.

Potential sources of revenue and/or cost avoidance might include:

- Peak shaving – reducing demand during peak energy price periods
- Transmission and distribution grid cost avoidance targeting TRIAD (winter 5-7pm) and peak “Red Zone” periods 4-7 pm (see note on paying for the grid)
- Demand side response services associated with Fast Reserve, STOR, Capacity Market, and Frequency Control by Demand Management (FCDM)
- Capacity Market Supplier Charge (CMSC) avoidance, which is set to significantly increase as the UK capacity market develops

If co-located with intermittent renewable energy generation, behind the meter energy storage solutions could also allow high energy users to maximise their own use of renewable generation and potentially avoid grid curtailment constraints.

The effectiveness of a behind the meter energy storage solution will depend on a close alignment between the system power and storage capacity specification and the end user energy demand profile. Systems will deliver optimum benefit if they are sized to meet end user energy demand and if that demand is consistently high during peak price periods, so suitable high energy users may include industrial manufacturers, data centres, hospitals, private wire networks and other commercial users.

Given the need to match energy storage with demand, it is likely that energy storage systems for high energy users will be designed to deliver relatively low power outputs (compared to grid services) of 50 kW – 3 MW, but for longer periods of 2-4 hours or potentially longer.

### High energy industrial user with co-location

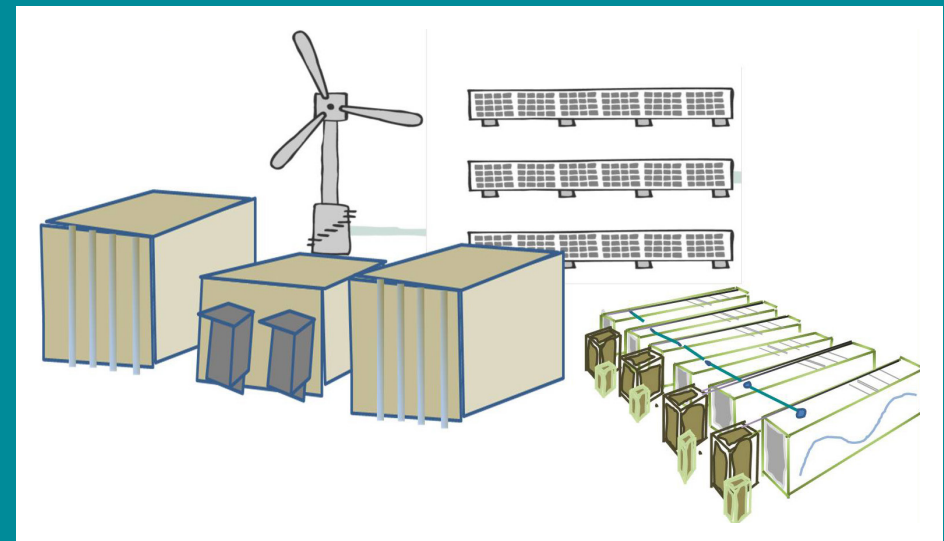

### Key issues and commercial considerations

- Need to align system specification and operations with energy demand profile
- Longevity and stability of future energy demand
- Potential changes to transmission and distribution cost charging
- Potential changes to grid connection agreements

## Domestic and community model

The domestic energy storage market in the UK is at an early stage of development, with the majority of deployment funded by government and Innovate UK trials looking into aggregating domestic storage to provide network services. Beyond these trials, it is difficult to assess the total number of installations, as there is currently no centralised mechanism for recording deployment.

In Germany, the situation has been different, as a 25 per cent grant payment for domestic energy storage encouraged much faster uptake, to the point where storage systems were being fitted as “standard” for 41 per cent of new PV installations in 2015<sup>23</sup>, with 4.4 kWh systems selling at between € 5,500-7000.<sup>24</sup> As global lithium-ion battery prices continue to fall through larger scale manufacturing and innovation in system design, it is expected that the UK domestic storage market will expand, led by new technologies, such as the Tesla Powerwall, Powervault, Maslow, Sonnen and Wattstor.

### Domestic rooftop PV and storage

The simplest application for domestic energy storage is a standalone battery connected to on-site PV. The battery works in isolation from the network and delivers a cost saving benefit to the occupier, by time-shifting energy use to avoid times of peak pricing.

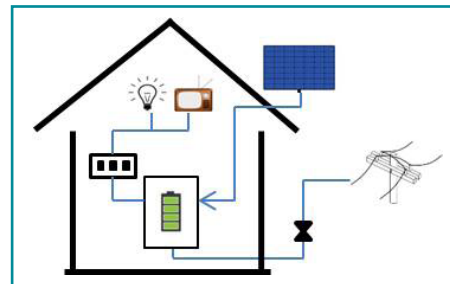

At current battery prices, payback periods are estimated to be in excess of 15-20 years<sup>24</sup>; therefore, deployment of domestic energy storage under this model is likely to depend on other consumer purchasing decisions. However, the combination of falling battery prices, the UK smart meter roll out and the development of more sophisticated time of use tariff (TouT) signals will reduce payback periods.

### Community aggregation

The development of systems to aggregate multiple domestic and larger community owned storage assets is the current focus of industry based research. Aggregating storage systems permits greater control over multiple demand profiles and can lead to increased revenues when combined with sophisticated network signal technology.

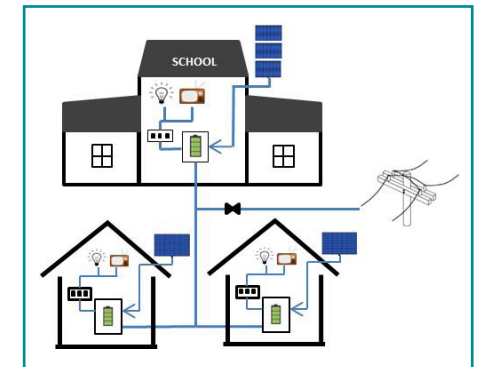

Innovations, such as the German based ‘sonnenBatterie Community’ platform, also allow owners of storage to trade excess energy through online platforms with the members of the Community through aggregated sleeving arrangements. The Carbon Trust has recently reported that aggregated storage systems can reduce payback periods to fourteen years under a fixed tariff system<sup>25</sup>.

Aggregated storage assets with the application of time of use tariffs (TouT) further reduce payback periods by utilising dynamic pricing mechanisms to maximise cost benefits. By charging more for energy at times of peak network load, incentivising the on-site use of storage in these periods, and providing a cheaper flat rate tariff in off peak periods, payback periods can fall further to nine years<sup>25</sup>.

<sup>23</sup> KfW Development Bank data – cited Energy Post July 18th 2016

<sup>24</sup> Cited Greentech Media March 4th 2016

<sup>25</sup> Can storage help reduce the cost of a future UK electricity system? Carbon Trust, Imperial College London (2016)

## Domestic and community rooftop PV plus frequency support and/or energy reserve services

With changes to network regulations governing frequency services on local grid networks, aggregated storage systems could provide additional benefits beyond energy cost reductions to the storage asset owners. This model could take the form of a third party managing the aggregated system to provide cost benefit to the storage asset owner via dynamic pricing, in addition to providing frequency services to the local network operator at times where there is capacity to do so. Layering this additional service revenue onto a dynamically priced aggregated system could reduce payback periods to seven years<sup>23</sup>.

With the anticipated development of greater flexibility in the UK energy system and the potential for local balancing of demand and supply within the distributed grid network, aggregated storage systems have the potential to provide infrequent grid services to the Distribution Network Operator (DNO) to aid in balancing local grid networks. Additional revenue from these services could further reduce payback periods to five years<sup>23</sup>.

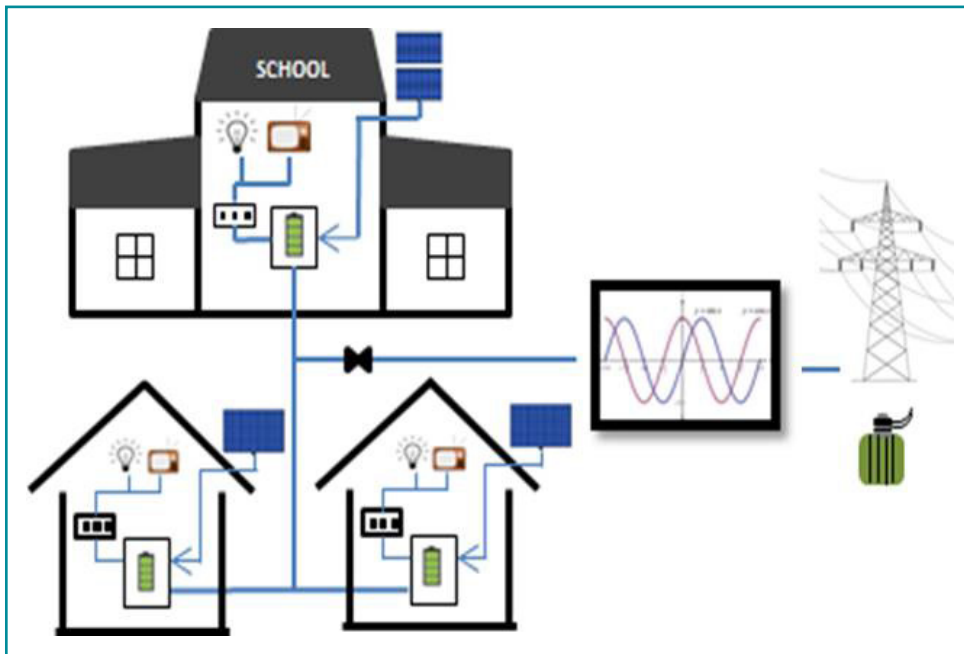

### Key issues and commercial considerations

- Financing arrangements, given long payback periods
- Need to align system specification and operations with energy demand profile
- Aggregation and system integration complexity
- System performance, certification and insurance

## Energy reserve model

Providing energy reserve services to the grid to balance network demand is already an established energy storage business model and has been the basis for pumped hydro systems, such as the 1.72 GW Dinorwig facility in Gwynedd, which has been in operation since 1984, primarily offering STOR services.

The UK requirement for reserve services, especially STOR and the Capacity Market, is expected to grow over the short/medium term in response to falling capacity margins and the need to secure existing and new capacity to replace older fossil fuel and nuclear power stations.

While generally offering a lower value revenue stream, compared to response services, the reserve service market is much larger and can offer energy storage providers a “base” revenue that could be combined with other revenue sources, such as price arbitrage and network cost avoidance.

The main reserve services operating in the UK which could be suitable targets for energy storage include:

- **Fast Reserve** – short term contracts (typically <6 months) to provide rapid response (<2 min) for short duration (<15 mins) during morning and evening peaks with a minimum power output of 50 MW, offering a high value revenue stream of circa £40-50k per MW per year.
- **Short Term Operating Reserve** – seasonal contracts to provide a ramp-up within 20 mins for up to 2hr duration with a minimum power output of 3 MW, offering a more modest return depending on utilisation of circa £20-40k per MW per year.
- **Capacity Market** - annual (longer for new plant) contracts to provide 2 MW or more peak demand capacity within 4 hours with potential revenues (based on 2015 auctions) of £18-20k per MW per annum. This figure could increase potentially to >£30k per MW per annum pending the outcome of future auctions<sup>26</sup>.
- **Demand Side Response** – “negative generation” options for high energy users “behind the meter” model.
- **Aggregation** – variation on all reserve services to meet minimum power requirements through aggregation.

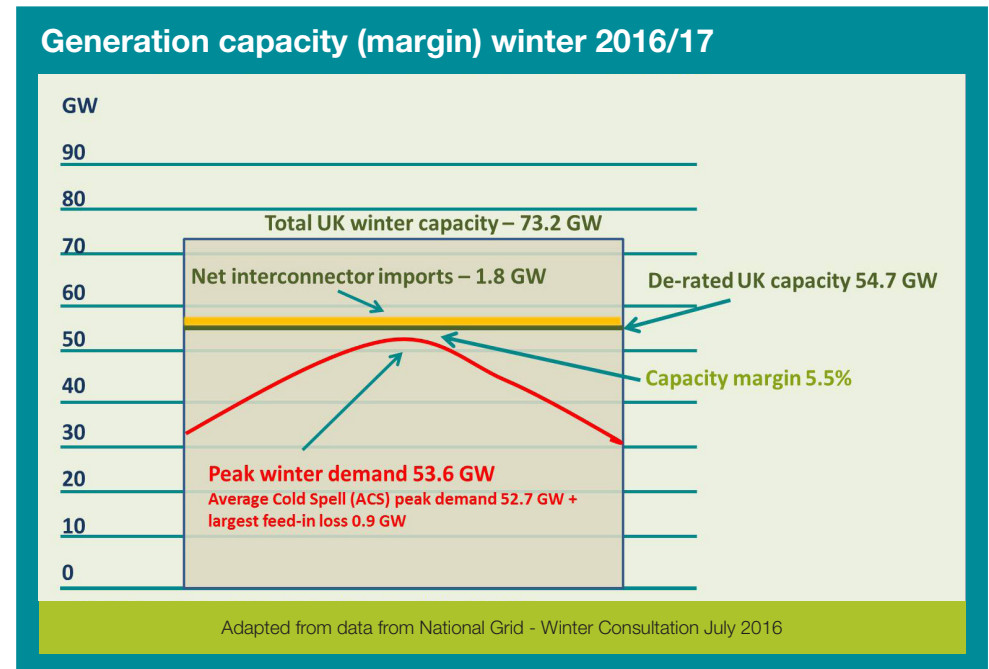

<sup>26</sup>Based on pre-auction speculation and media reports for example: Utility Week “Capacity auction unlikely to secure new gas: Cornwall Energy”

The storage system requirements to provide reserve services vary. Fast Reserve would be suitable for a rapid response battery system potentially enabled through aggregation to meet the 50 MW power output requirements. STOR and Capacity Market services, or their demand side response equivalents, offer a lower return, but a less onerous service requirement.

As a standalone service, it would be difficult to build a sustainable business model for a battery energy storage system based on reserve services alone. Energy discharge during peak demand periods is, however, consistent with targeting price arbitrage and network cost avoidance, and as storage capacity costs fall, it is expected that larger energy reserve projects will become more attractive.

At a larger scale, pumped hydro is already widely deployed and in the future Compressed Air Energy Storage (CAES) systems and alternative battery (NAS and Flow battery) systems, offering larger storage capacities, could potentially provide balancing services.

### Key issues and commercial considerations

- Growing market – although competition from interconnection and other flexible forms of generation
- Low value revenue stream, but potential to combine with other revenue sources
- Revenues based on utilisation are uncertain
- Increase in penalties for non-delivery
- Larger storage capacity requirement, but costs are expected to fall rapidly
- Opportunities for demand side response and aggregation
- Potential changes to grid connection agreements

### 2016 Capacity Market Pre-Qualification features energy storage

The forthcoming Capacity Market T4 auction could prove to be another significant milestone for the energy storage market. The results of the pre-qualification have now been published showing over 4 GW of potential energy storage bids, of which over 1.5 GW is new build battery storage across over 100 sites.

There is some overlap with the tenders submitted for Enhanced Frequency Response auction, which suggest that battery storage developers are assuming that EFR will be classified as a “relevant balancing service” which would allow EFR operators to participate in the capacity market without risking non-service penalties. Significantly there are also a significant number of new tenders which shows again the strength of the energy storage pipeline.

A big question is whether energy storage can outcompete the large number of diesel generators and gas reciprocating engines that are also expected to be bidding. If they can then the 2016 auction will mark a major transition in the balancing service market.



## Energy trader

Intuitively, the ability to store energy when it is cheap and deliver it at a time when it is needed at a higher price would be expected to form the basis for a viable business case for any variable energy generator or supply company, even more so in an energy system characterised by large variance in demand, price volatility and increasing levels of variable generation.

However, a viable time/price shift business case based solely on price variance is very difficult for energy storage projects, even in the scenario where an energy trader is a grid curtailed generator. In large part, this is due to: the cost of energy storage capacity; the large capacity needed to capture significant variable generation; and the loss of energy due to cycle (round-trip) efficiency.

The conclusion, therefore, is that, given the current costs of storage technology, an energy trader price variance business model really only works in conjunction with other business model revenue streams. That conclusion could well change as energy storage costs fall relative to the overall peak and variable energy price.

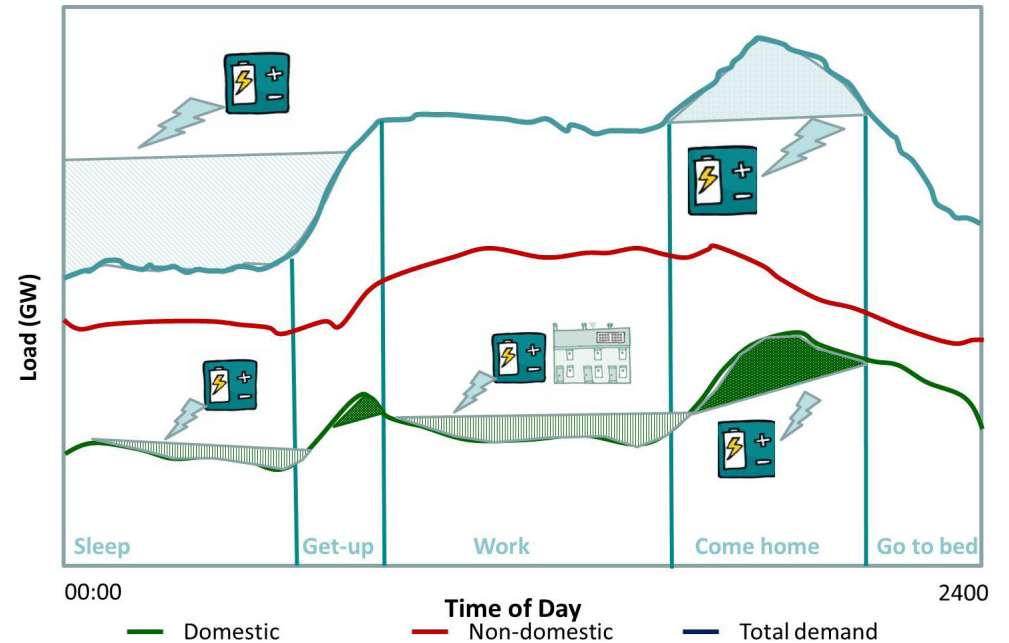

| Commercial scenario                                              | Basis of business case                                                                                                                                    | Viability                                                                                                                                                                                                                                                                                                                                            |
|------------------------------------------------------------------|-----------------------------------------------------------------------------------------------------------------------------------------------------------|------------------------------------------------------------------------------------------------------------------------------------------------------------------------------------------------------------------------------------------------------------------------------------------------------------------------------------------------------|
| <b>“In front of the meter” energy trader</b>                     | Charging and discharging electricity from the grid at the market price taking advantage of price variance                                                 | Would suffer from unacceptable cycle efficiency losses and network charges (demand and generator) to outweigh the small revenue gain from market price variance.                                                                                                                                                                                     |
| <b>“Behind the meter” generator trader</b>                       | Co-location with variable generation (PV, tidal or wind) – charging during low wholesale price period and discharging during peak wholesale price period. | Difficult to manage efficiently. Cycle efficiency losses (including lost subsidy if applicable) would offset wholesale price variance gains.<br>A relatively large storage capacity, and therefore high capital investment, would be required to store significant variable generation.                                                              |
| <b>“Behind the meter” generator trader with grid curtailment</b> | Using storage to capture “free” and otherwise lost energy generation due to grid curtailment and discharging during peak wholesale price period.          | A better business case in that the full value (subsidies and wholesale price) of potentially lost energy is captured (less cycle losses)<br>However, would require a relatively cheap and large scale storage technology, coupled with high peak energy prices.<br>For example, pumped hydro in Norway or potentially compressed air energy storage. |

# Growth scenario for a future energy storage market

The recently published 2016 National Grid Future Energy Scenarios (FES) for the first time considered energy storage in more detail. The FES report presented a wide range of potential market outcomes for the sector, with the “Consumer Power” scenario showing the highest electricity storage deployment at over 18 GW of capacity by 2040, while the “Gone Green” scenario gave a slightly more modest 11.4 GW of storage.

The difference between these scenarios is mainly due to “Consumer Power” having greater decentralised generation and high growth in domestic and community storage applications. To put that into context, at the current price range for battery storage projects, the above scenarios would represent total capital investment of between £8-15 billion, or a market size akin to the current onshore wind market.

## Potential Energy Storage Growth Scenario 2040

|                                                | Today             | Short term 2025  | Medium term 2030 | Long term 2040 |
|------------------------------------------------|-------------------|------------------|------------------|----------------|
| <b>New commercial models</b>                   | Response services | High energy user | Energy reserve   | Energy trader  |
| <b>Major function</b>                          | Response          | Reserve          | Price/time shift |                |
| <b>Relative storage value</b>                  | Higher            | High             | Low              | Low            |
| <b>Storage costs</b>                           | High              | Falling          | Low              | Lower          |
| <b>System scale</b>                            | Small             | Smaller          | Large            | Variable       |
| <b>Power/Capacity ratio</b>                    | 2:1               | 1:(2-4)          | 1:(2-6)          | 1:(1-3)        |
| <b>Total energy storage capacity potential</b> | 2-3 GW            | 5 GW ++          | 10 GW ++         | 15 GW ++       |

At the other end of the scale the “No progression” scenario, as the name implies, showed a low level of storage deployment at 3.6 GW by 2040, barely more than currently deployed; arguably this scenario should be discounted, as it would not deliver the level of decarbonisation to which the UK is legally committed.

The current base of operational storage capacity is a little over 3 GW, which is mainly made up of pumped hydro. The question, therefore, is to understand the likely development pathway for market growth.

Our analysis suggests a likely development pathway for large scale storage in a number of overlapping “phases”, with initial deployment focused on providing high value “response services”, such as auxiliary services to the grid. From a commercial perspective, there are two main drivers for this. Firstly, as has been said, the current state of battery storage technology and the cost model for battery based systems tends to favour comparatively high power and rapid response capability, rather than large storage capacity. Secondly, these services offer a clear route to market and an investment return, albeit via a highly competitive tender process.

Alongside high value response services, the “high energy user, behind the meter” model could also become a commercially viable storage investment. This model has the attraction of multiple revenue streams and provides an inherent cost reduction value to an end customer which, although it may be impacted by regulatory uncertainty, is likely to provide a degree of long term revenue security. Market growth in this area is likely to be characterised by a larger number of relatively small storage projects, tailored to the energy user demand profile, but also opening opportunities for aggregation.

Future growth in energy reserve services and energy trader models (price arbitrage) could open significantly larger markets, but will depend greatly on the rate of energy storage cost reduction. If costs fall dramatically, as expected, then energy storage will be able to play a much wider role, providing flexibility, to address the UK’s future energy needs.

The market growth scenario for smaller scale domestic, community and vehicle related energy storage is equally exciting. As has been seen in Germany, once domestic systems reach a cost benefit tipping point, uptake is likely to be quite rapid. This outlook is shared by Regen SW members that are selling and installing domestic systems and who anecdotally report that the customer appetite for storage is growing. Barring technology risks, it is therefore mainly a question of time and cost reduction before domestic storage solutions become commonplace.

It is difficult to give an estimate of domestic market growth – as we saw with PV's exceptionally rapid and unexpected expansion – but, extrapolating the analysis that Regen SW completed for Western Power Distribution in their South West<sup>27</sup> and South Wales licence areas across the UK suggests that we could see over 250,000 to 350,000 domestic energy storage solutions installed by 2030. This would still represent less than 4 per cent of the circa 25 million UK households.

Beyond the “own use” domestic consumer market, the opportunities for energy storage are potentially limitless. There is a future energy scenario where energy storage in one form or another becomes ubiquitous. Every household, every car and vehicle, individual appliances – aggregated, integrated and linked by smart systems – could contain energy storage technology; add to that the “multi-vector” potential to convert, store and transfer energy between power, heat and transport, and energy storage has the potential to completely change the way in which we use and generate electricity.

“From the tumbling cost of batteries to super-efficient lightbulbs, from cleaner forms of electricity generation to the commercial promise of, and now the reality, of electric vehicles, I think we are seeing intense technological innovation in every part of the energy system.

“Advances in storage technologies offer the promise of managing the grid more effectively, more cheaply, avoiding the need for expensive new power stations or wires.”

Greg Clark, Secretary of State, BEIS, Nov 2016

<sup>27</sup>Western Power Distribution South West Future Growth Scenarios 2015-2030

# Regulatory and legal constraints and issues

Energy storage is regulated in the UK under the Electricity Act 1989/27 and EU 'Electricity Directive' 2009/72/EC28.

It is not explicitly recognised as a discrete activity or asset class under the regulation definitions, subsequently being considered as a form of generation asset or end user for the purposes of licencing.

However, the definition of generation under the regulations is unclear and, given the technical characteristics of storage and the ability to argue for its definition as both a generation asset and end user asset, it does not sit easily within the regulation definitions as they currently stand.

The policy and regulatory landscape for storage is rapidly evolving and Ofgem and the Department of Business, Energy & Industrial Strategy (BEIS) are to publish a call for evidence in 2016, considering policy changes to facilitate greater use of flexibility in the electricity network, of which energy storage is one part.

The potential of energy storage is strongly linked to regulatory decisions and this reliance on a favourable regulatory framework raises some key interrelated barriers to the deployment of energy storage. These can be summarised as:

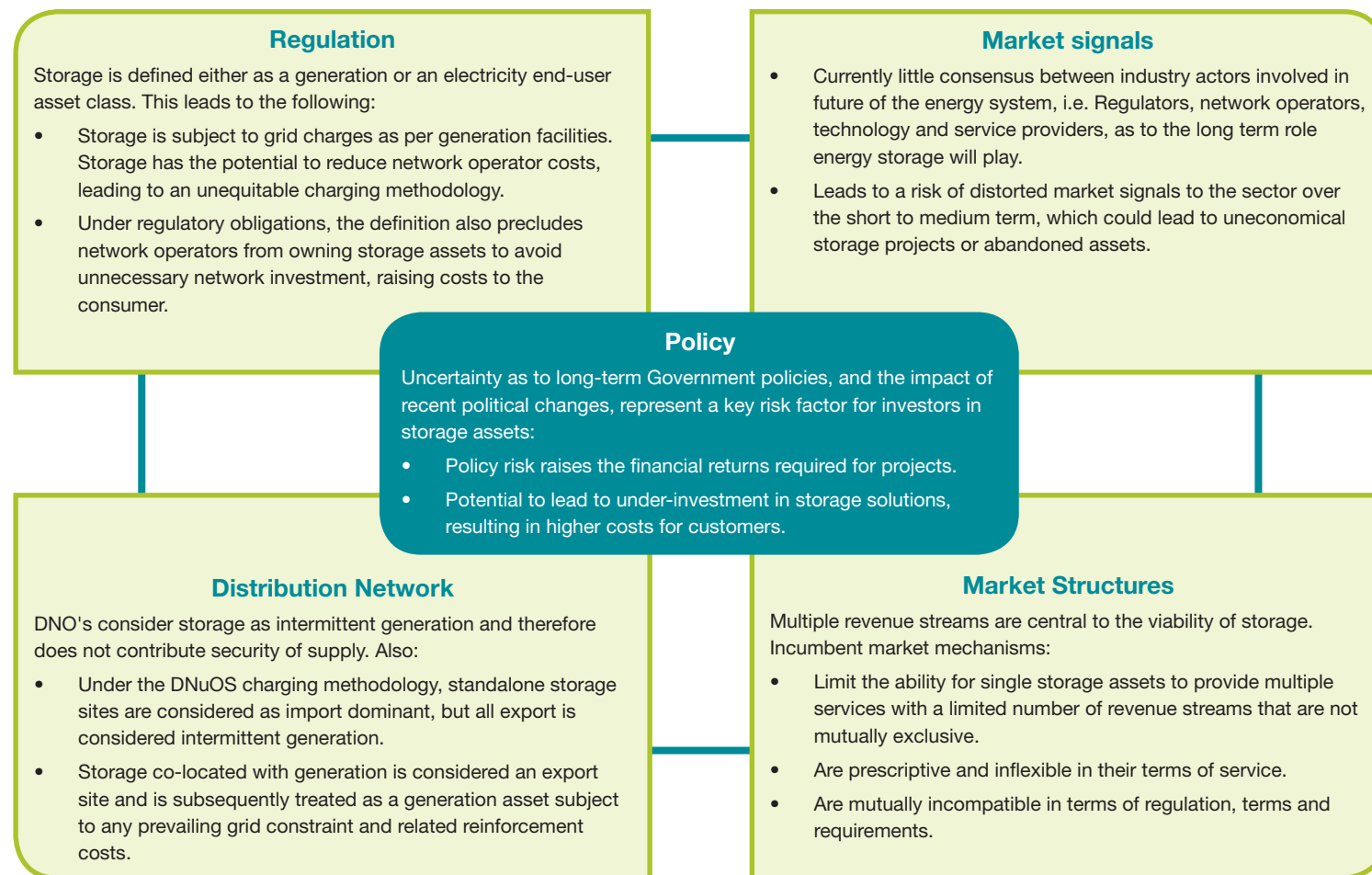

## Industry insight - Model specific legal issues

Over and above the regulatory issues common to storage projects in general, there will of course be legal issues specific to particular types of business model. As just one example, we are aware that a number of developers are looking at the scope for co-locating storage assets with existing/planned solar, wind or other renewable generation assets.

"Co-location of storage may or may not have been considered at the outset of a particular renewables project. Existing land options or leases, together with existing planning consents, will need checking to assess whether there is the necessary permission to install and operate the storage asset at the site.

"Arrangements for connecting the storage asset will also need careful consideration: depending on the particular configuration and metering arrangements, there may be a need to put in place some form of grid sharing agreement and to assess whether existing FIT or RO accreditation and PPA arrangements are affected by the proposed co-location."

Maria Connolly, Head of Energy & Renewables and Real Estate at TLT

The current regulatory framework was designed to liberalise and promote competition between the incumbent technology providers within the UK energy market. Subsequently, electricity storage projects are looking to work within a framework that was not developed with the technology in mind. However, the nature of electricity demand is evolving.

The aim of electrifying heat and transport in the UK, in addition to the rise of "smart" technologies, will have the impact of changing patterns of consumption to one of increased flexibility on both supply and demand sides, leading to greater variability and unpredictability in patterns of consumption and generation.

Therefore, as the role and need for energy storage develops and as the UK moves towards a more flexible energy system to meet its binding decarbonisation targets, without regulatory change, the challenges faced by energy storage providers will increase.

## Key enablers identified as being required include:

|                                     |                                                                                                                                                                                                                                                                                                                                                                                                                                                                                                                                                                                                                                                                                                                                                                                        |
|-------------------------------------|----------------------------------------------------------------------------------------------------------------------------------------------------------------------------------------------------------------------------------------------------------------------------------------------------------------------------------------------------------------------------------------------------------------------------------------------------------------------------------------------------------------------------------------------------------------------------------------------------------------------------------------------------------------------------------------------------------------------------------------------------------------------------------------|
| <b>Definition</b>                   | 1. Clarity on the role and definition of storage, including the potential for a new licence definition                                                                                                                                                                                                                                                                                                                                                                                                                                                                                                                                                                                                                                                                                 |
| <b>Grid charging methodology</b>    | 2. Ensure that the forthcoming reform of network charging takes an holistic view and ensures a level playing field for energy storage technologies, demand side response and other form of system flexibility                                                                                                                                                                                                                                                                                                                                                                                                                                                                                                                                                                          |
| <b>Smart technology</b>             | 3. Accelerate roll-out of smart meters and the uptake of Time of Use Tariffs to enable more consumers to take advantage of price arbitrage opportunities                                                                                                                                                                                                                                                                                                                                                                                                                                                                                                                                                                                                                               |
| <b>End user levies</b>              | 4. Elimination of instances of double charging (demand and generation) for end user levies and other network charges                                                                                                                                                                                                                                                                                                                                                                                                                                                                                                                                                                                                                                                                   |
| <b>Network services regulations</b> | <p>5. Measures to ensure that energy storage can fully access network service revenues – for example distribution network (DNUoS) banded tariff credits</p> <p>6. Provide clarity on the scale and timing of the commissioning of future balancing and auxiliary services and adapt service specification to encourage competition from energy storage solutions</p> <p>7. Ensuring that the transition towards a Distribution System Operator model supports the development of local network balancing using energy storage and other flexibility services</p> <p>8. Ensuring a coherent and consistent approach to the procurement of network services (National Grid and DNO/DSO services) allowing services to be appropriately bundled to create longer term revenue streams</p> |

# Conclusion - Towards a commercial future

## Market outlook

The storage Rubik's Cube™ is not quite solved, but with some greater realignment between energy storage technologies, regulatory framework, revenues and costs, the global and UK energy storage market is poised to achieve substantial market growth. If that happens, energy storage could make a substantial contribution to the overall UK energy system, adding much needed flexibility and allowing the further expansion of low carbon technologies to achieve our decarbonisation targets.

The analysis presented in this report supports the overall conclusion that the development of the energy storage sector is on the cusp of commercial reality.

Our market analysis conclusions are that:

1. A market growth projection towards an UK energy storage sector in excess of 10 GW power capacity in the 2030's is achievable.
2. In the short term battery storage projects will tend to focus on higher value rapid response and targeted network cost avoidance revenue streams but as storage capacity costs fall, and with technology innovation, in the next decade reserve and time/price shift solutions will become viable.
3. Larger mechanical storage solutions using pumped hydro and potentially compressed air energy storage could also play a role to offer reserve and balancing services.
4. Of the illustrative business models analysed the "response service" and the "high energy user - cost avoidance" models are the most immediately attractive with the major caveat that future changes to the transmission and distribution grid charging regimes may have a significant impact.
5. Domestic and community scale energy storage could also become viable in the near term as battery storage costs fall leading potentially to the ubiquitous use of energy storage in our homes, workplaces and in transport.

## Regulatory and policy enablers

To enable the energy storage, and the wider smart energy sector, to reach its full potential a number of regulatory and policy initiatives are needed.

1. A clear commitment to decarbonisation and the development of a decentralised and flexible energy system, as outlined in the National Infrastructure Commission's Smart Power report, would greatly help to provide strategic direction and build market confidence.
2. It is essential that the UK continues to support technology development and the demonstration of new business and operating models. Particularly post Brexit the UK should commit to provide on-going innovation and pilot project funding into the 2020's.
3. Ensuring that any proposed changes to the charging regime for transmission network costs support innovation and the provision of low carbon flexibility services by ensuring a level playing field for energy storage technologies, demand side response and other form of system flexibility.
4. The end user licence definition of energy storage and how it is treated within the charging, regulatory and policy framework needs to be clarified. This should support the removal of instances of double charging for energy storage, for example end user network charge levies, and enables energy storage to fully access revenue streams to compete effectively in the market.
5. Ensuring that the transition towards a Distribution System Operator (DSO) encourages, and does not inhibit, distributed generation and local network balancing utilising energy storage and other flexibility services.

## Building a smart power industrial strategy

The UK is in an excellent position to exploit this new technology and market area in conjunction with a smart energy industrial strategy. The UK is developing more advanced and innovative energy storage applications that incorporate multiple revenue streams, sophisticated system management tools, aggregation and grid integration. These “smart” energy storage systems could form the basis of a global export opportunity and provide economic value in areas such as systems engineering and architecture, information and communication technology, systems management tools, aggregation and the development of integrated solutions.

It is important, therefore, that the UK builds on its current position and creates a positive environment to support market growth. The announcement that over 200MW of National Grid Enhanced Frequency Response contracts have been awarded to energy storage technologies is a great starting point and a boost for the industry. This result demonstrates that, given the right market incentives, energy storage technology is now ready for commercial investment.

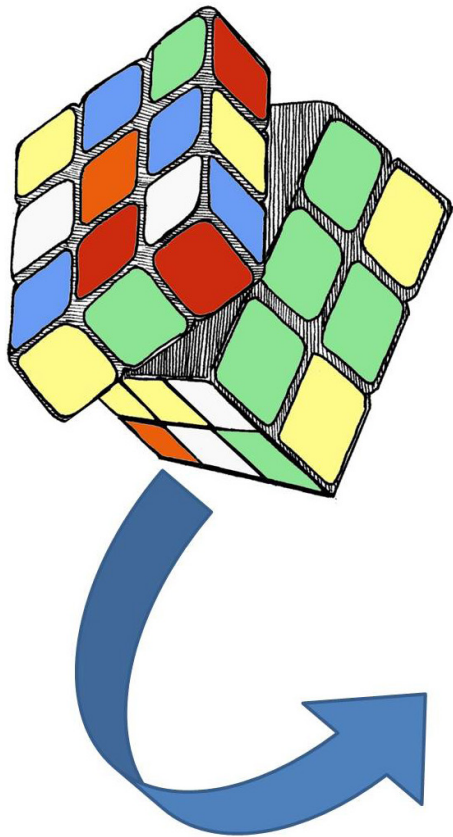

"We are constantly looking to the future to understand how we can make the most of the energy available to us. This project is at the very core of our Power Responsive work, to balance the Grid by the most efficient means possible, saving money and energy.

"These awards show that we can work with industry to bring forward new technology and I believe storage has much to contribute to the flexible energy system of tomorrow. This is the beginning of an exciting new chapter for the industry."

Cordi O'Hara, Director of UK System Operator, National Grid

Those winning tenders will now be finalising their financial commitments and moving ahead with project construction, and it will be important now that the UK government and its agencies continues to ensure that the regulatory and policy framework is in place to ensure all those projects are realised.

The Department of Business, Energy and Industrial Strategy and Ofgem have now issued their call for evidence on a “Smart, Flexible Energy System” with responses expected by January 2017.

Regen will be responding to this call for evidence which we hope will focus on not only the value that flexibility can bring to the energy system, but also on the wider industrial strategy that could be developed to ensure that UK based industry, innovation and knowledge providers are at the forefront of the industry.

# Reference documents and further reading

**Carbon Trust:** Energy storage report: can storage help reduce the cost of a future UK electricity system? 2016

**Committee on Climate Change:** The Fifth Carbon Budget – The next step towards a low-carbon economy Nov 2015

**Cornwall Energy:** A Review of the Embedded Benefits accruing to Distribution Connected Generation in GB May 2016

**Energy Storage Association:** <http://energystorage.org/>

**Energy Storage Network:** <http://www.electricitystorage.co.uk/about-us>

**Eunomia:** Investing in UK Electricity Storage 2016

**Imperial College and NERA:** Value of Flexibility in a Decarbonised Grid and System Externalities of Low-Carbon Generation Technologies, for the Committee on Climate Change, 2015

**IRENA:** Battery Storage for Renewables Market Status and Technology Outlook 2015

**Major Energy Users' Council, in association with National Grid report:** Profiting from Demand Side Response 2016

**National Grid:** Balancing Services On-line reports and market assessment

**National Grid:** Enhanced Frequency Report Market Information report, 26th August 2016

**National Grid:** Future Energy Scenarios 2015 and 2016

**National Infrastructure Commission:** Smart Power, 2016

**Ofgem:** Making the electricity system more flexible and delivering the benefits for consumers, 2015

**Ofgem:** Open letter

**Regen SW (sponsored by the European Climate Foundation):** Electricity network charging for a flexible future, August 2016

**Regen SW:** A local progress report for England 2016

**Regen SW:** Distributed generation and demand study – technology growth scenarios to 2030, January 2016

**Rocky Mountain Institute:** The Economics of Battery Energy Storage

**The Major Energy Users' Council in association with National Grid report:** Profiting from Demand Side Response 2016

**US Department of Energy:** Energy Storage Datasets

**Western Power Distribution:** South West Future Growth Scenarios 2015-2030

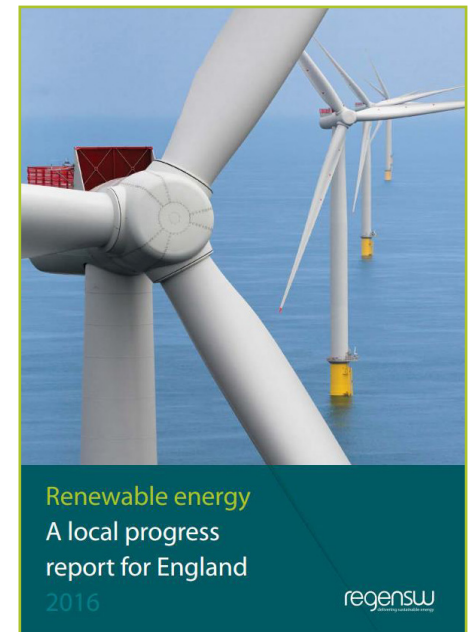



Regen SW, The Innovation Centre, Rennes Drive, Exeter, EX4 4RN  
T +44 (0) 1392 494399 E admin@regensw.co.uk www.regensw.co.uk  
Registered in England No: 04554636

Sponsored by:



Triodos  Bank